

# Alape<sup>U</sup>

## Product List

Valid from the 1st of April 2022

A<sup>U</sup>form – Glazed Steel  
Washbasins, washstands  
and washplaces

# Ãform

**WP / AG**

**WT / WT.RX**

**AB / SB**

**EB / HB**

**UB**

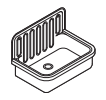
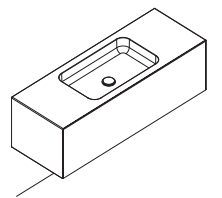
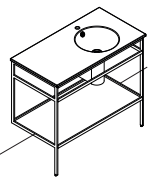
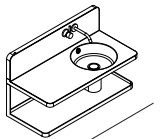
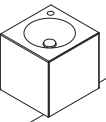
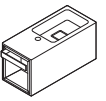
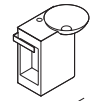
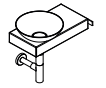
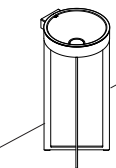
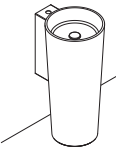
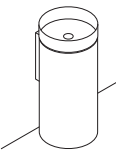
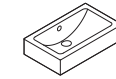
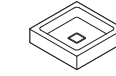
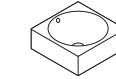
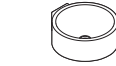
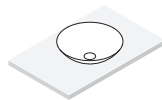
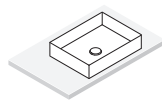
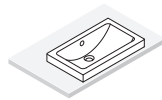
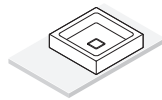
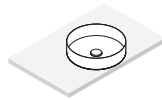
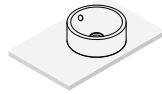
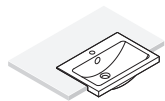
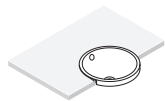
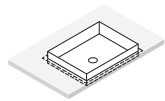
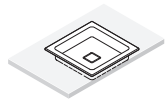
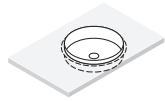
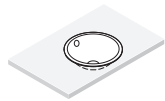
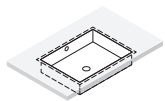
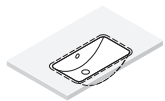
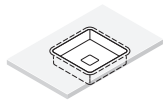
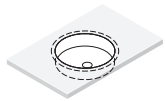
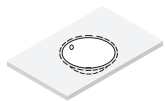

**UB** – Undermount basins

**EB** – Built-in basins  
**HB** – Semi-recessed basins

**AB** – Sit-on basins  
**SB** – Dish basins

**WT** – Washstands

**WP** – Washplaces  
**AG** – Bucket sinks

# Contents

## A~form

General notes / manufacturer's warranty _____	004-005
Novelties 2021/2022 / Discontinued articles _____	006
Article index _____	007-011

<b>Installation types</b> _____	012-013
---------------------------------	---------

## Material

Glazed Steel _____	014-015
--------------------	---------

## Individualisation

Made-to-measure washplace _____	016-017
Individualisation in detail _____	018-019

<b>Tap fitting and drill holes information</b> _____	020
--	-----

## Technical information

<b>UB Undermount basins</b> _____	022-037
-----------------------------------	---------

Overview of basins _____	023
UB.K, .KE, .SO, .O, .ME, .SR, .R, .RE, .Q, _____	024-037

<b>EB Built-in basins</b> _____	038-063
---------------------------------	---------

Overview of basins _____	039
EB Built-in basins _____	040-062
EW, EB.S, .K, .KE, .O, .ME, .SR, .R, .RE, .Q	
HB Semi-recessed basins _____	063
HB.S, .R	

<b>AB Sit-on basins</b> _____	064-077
-------------------------------	---------

Overview of basins _____	065
AB.K, .KE, .SO, .ME, .SR, .R, .RE, .Q, _____	066-077

<b>SB Dish basins</b> _____	078-083
-----------------------------	---------

Overview of basins _____	079
SB.K, .CO, .O, .SR _____	080-083

<b>Special glazing</b> _____	084-099
------------------------------	---------

Overview of basins and washstands _____	085
Aqua _____	086-087
Terra _____	088-089
Bicolor _____	090-092
Matt black _____	093-095
Metallic _____	096-099

<b>WT Washstands</b> _____	100-135
----------------------------	---------

Washstand overview (WT) _____	101
WT Floor-standing washstands _____	102-110
WT.RX – with wall connection _____	102-108
WT.RX – freestanding _____	109-110
WT Wall-mounted washstands _____	111-135
WT.RS _____	111-112
Scopio (WT.CO) _____	113
WT.IC _____	114-115
WT.MC _____	116-117

Fusion.S (WT.XXS) _____	118-119
-------------------------	---------

WT.QS _____	120-124
-------------	---------

Xplore.S (WT.XS) _____	125-126
------------------------	---------

Stream (WT.SR) _____	127
----------------------	-----

WT.PR _____	128-131
-------------	---------

WT.GR _____	132-133
-------------	---------

X.plicit (WT.RE) _____	134-135
------------------------	---------

<b>WP Washplaces</b> _____	136-163
----------------------------	---------

Overview of washplaces made from glazed steel (WP) _____	137
---	-----

Insert (WP.Insert) _____	138-139
--------------------------	---------

Piccolo Novo (WP.PN/SET.WP.PN) _____	140-141
--------------------------------------	---------

Fusion.S (WP.XXS) _____	142
-------------------------	-----

Xplore.S (WP.XS) _____	143
------------------------	-----

Steel19 (WP.S19.1, WP.S19.L1/.L2) _____	144-146
---	---------

Work.Frame (WP.WF) _____	147-149
--------------------------	---------

Accessories Work.Frame (SV.WF) _____	150-151
--------------------------------------	---------

Overview of washplaces with cabinets (WP) _____	153
---	-----

Folio (WP.Folio) _____	154-159
------------------------	---------

Accessories Folio _____	160-163
-------------------------	---------

<b>AG Bucket sinks</b> _____	164-167
------------------------------	---------

<b>Assist shelf system</b> _____	168-173
----------------------------------	---------

Overview shelves _____	169
------------------------	-----

Shelves _____	170-173
---------------	---------

<b>Mirrors and lighting</b> _____	174-185
-----------------------------------	---------

Overview of design mirrors SP.FR _____	175
--	-----

Design mirrors SP.FR _____	176-179
----------------------------	---------

Lights _____	181
--------------	-----

Mirror SP. _____	182-185
------------------	---------

<b>Accessories</b> _____	186-189
--------------------------	---------

For basins, washstands,  
and washplaces

<b>Spare parts</b> _____	190-191
--------------------------	---------

For basins, washstands,  
and washplaces

Mounting and connection measurements _____	192-207
--	---------

Terms of Trading and Delivery _____	208-209
-------------------------------------	---------

Contact details _____	210-215
-----------------------	---------

Overview colors _____	217
-----------------------	-----

# General notes

With this price list, we are pleased to offer you our current range of basins, washstand and washplaces. As a specialist for surfaces and colours, we have expanded our range and offer, for example, an exclusive selection of basins in the trend colour matt black. New elegant washbasin columns in a filigree design also expand our portfolio.

## **Novelties | Current range**

From page 6 you will find a list of our novelties, the discontinued articles and the article index of our current portfolio.

## **Variable installation types for basins**

Alape offers an extensive range with regards to systematic variety. It includes undermount-, built-in and semi-recessed basins, as well as sit-on and dish basins. On page 12 you will find information about the benefits of every installation type.

## **Fittings information**

Please refer to the price list in the product descriptions for information on the optimum water impact area on the basin mold.

## **Colours**

Our basins, washbasins and washing plates made of glazed steel are by default in white surface. On page 217 you will find an overview of which series are for surcharge also available in the current glossy and matt colours. In addition, in the chapter Special glazes you will find selected basins and washstands in a wide variety of colors and surfaces.

## **Service team**

Our service team provides partner-like and competent support. You can reach the team on +49 (0)5321.558-111 or [service@alape.de](mailto:service@alape.de).

## **Technical Data**

We have collated all important information for you as a planning professional at [www.alape.com](http://www.alape.com). Here you can find more extensive information and technical details for each product, such as CAD data, descriptive texts or declarations of performance.

# 25 years manufacturer's warranty

Alape basins and washstands made of glazed steel are particularly resistant and long-lasting. Therefore, since 2021, we have been giving a voluntary manufacturer's warranty of 25 years for these products.

## Warranty conditions

This warranty is subject to the proper use of the product and the correct care of the glazed surface in accordance with Alape's current cleaning and care instructions.

Detailed information about our warranty conditions can be found on our website [www.alape.com](http://www.alape.com) or via our QR code.

## Care of glazed steel

Enamelled surfaces should be rinsed with clean water after every use and subsequently wiped with a soft cleaning cloth.

In order to remove dirt, we recommend a soft sponge or a micro-fibre cloth and a standard, non-abrasive cleaning agent. Lime scale deposits should be cleaned off regularly in order to avoid any permanent damage to the surfaces.

Never leave cleaning and care products on the glossy or matt enamelled surface for extended periods. Remove residues from the surface immediately after use by rinsing with warm water, then rub the surface dry.

The use of the following aggressive cleaning agents, which can scratch and damage surfaces, must be avoided at all costs: scouring agents in liquid or powder form, highly-concentrated drain cleaners, cleaning agents for tap fittings or stainless steel, toilet cleaning powder. Abrasive cleaning equipment which could damage surfaces should also not be used.

Note:

All information is based on careful research and practical experience, and do not exclude you from doing your own tests. They are provided to the best of our knowledge and are not legally binding.



> [alape.com](http://alape.com)



# Novelties

Article	Name	Finish	Page
<b>Sit-on basin</b>			
3509 000 000	AB.SO400.1	White	070
<b>Special glazes</b>			
<b>Sit-on basins</b>			
3222 000 240	AB.KE400	Matt black	093
3503 000 240	AB.SO450.1	Matt black	094
3509 000 180	AB.SO400.1	Bicolor	090
3509 000 190	AB.SO400.1	Dark Iron	097
3509 000 240	AB.SO400.1	Matt black	093
<b>Dish basins</b>			
3501 000 240	SB.K360.GS	Matt black	094
3501 500 240	SB.SR650	Matt black	095
3521 500 081	SB.SR650	Oyster matt	089
3521 500 082	SB.SR650	Silk matt	089
3521 500 083	SB.SR650	Nordic matt	089
3521 500 084	SB.SR650	Gravel matt	089
<b>Floor-standing washstands</b>			
4508 500 000	WT.RX400.CU	White	103
4508 800 000	WT.RX400H.CU	White	103
4509 500 240	WT.RX400.CR	Matt black	102
4509 800 240	WT.RX400H.CR	Matt black	102
<b>Mirrors</b>			
6736 002 899	SP.2 – 1200 mm	Aluminium	184

# Discontinued items

Article	Name
<b>Mirrors</b>	
6716 004 899	SP.325.4
6717 004 899	SP.450.4
6718 000 899	SP.580
6718 004 899	SP.580.4
6719 002 899	SP.300.2
6720 002 899	SP.300C.2
6729 000 899	SP.1 – 800 mm
6729 001 899	SP.1 – 1000 mm
6729 014 899	SP.1 – 1250 mm
6736 014 899	SP.2 – 1250 mm
<b>Lights</b>	
8010 001 978	LE.1
8017 000 978	LE.7

## Article index

Article	Name	Page	Article	Name	Page
<b>Undermount basins</b>			2101 000 000	EB .0525	052
2030 700 000	UB .K325	024	2101 100 000	EB .0525	052
2031 700 000	UB .K400	024	2102 000 000	EB .0500H	051
2032 700 000	UB .K450	025	2102 100 000	EB .0500H	051
2110 700 000	UB .0425	031	2104 000 000	EB .0600H	053
2111 700 000	UB .0525	031	2104 100 000	EB .0600H	053
2250 700 000	UB .R585	035	2201 000 000	EB .R585	058
2251 700 000	UB .R800	036	2201 100 000	EB .R585	058
2255 700 000	UB .SR650	035	2202 000 000	EB .R585H	057
2258 500 000	UB .RE700 .4	036	2202 100 000	EB .R585H	057
2312 500 000	UB .Q450	037	2203 000 000	EB .R800	060
3223 501 000	UB .KE325	026	2203 200 000	EB .R800	060
3223 504 000	UB .KE325	026	2204 000 000	EB .R800H	059
3224 501 000	UB .KE375	027	2204 200 000	EB .R800H	059
3224 504 000	UB .KE375	027	2207 000 000	EB .RE700 .4	061
3225 501 000	UB .KE400	028	2208 000 000	EB .RE700H .2	061
3225 504 000	UB .KE400	028	2218 500 000	EB .SR650	056
3226 701 000	UB .ME500	032	2218 700 000	EB .SR650	056
3226 704 000	UB .ME500	032	2219 600 000	EB .SR650H	055
3227 701 000	UB .ME750	033	2219 800 000	EB .SR650H	055
3227 704 000	UB .ME750	033	2226 503 000	EB .ME500	054
3228 701 000	UB .ME1000	034	2227 503 000	EB .ME750	054
3228 704 000	UB .ME1000	034	2302 000 000	EB .Q450	062
3505 501 000	UB .S0450 .1	029	2303 000 000	EB .Q450H	062
3505 504 000	UB .S0450 .1	029	2406 000 000	EB .S450H	042
3506 501 000	UB .S0450 .2	030	2406 100 000	EB .S450H	042
3506 504 000	UB .S0450 .2	030	<b>Semi recessed basins</b>		
<b>Built-in basins</b>			2700 000 000	HB .R585H	063
2000 000 000	EB .K325	043	2900 000 000	HB .S450H	063
2000 200 000	EB .K325	043	<b>Sit-on basins</b>		
2001 000 000	EB .K400	045	3000 200 000	AB .K325 .2	066
2001 100 000	EB .K400	045	3002 200 000	AB .K400 .2	067
2002 000 000	EB .K450	047	3004 200 000	AB .K400H .2	066
2002 100 000	EB .K450	047	3006 200 000	AB .K450 .2	068
2003 000 000	EB .K400H	044	3008 000 000	AB .K450H .2	067
2003 200 000	EB .K400H	044	3202 000 000	AB .R585H .1	074
2004 000 000	EB .K450H	046	3205 000 000	AB .R585 .1	074
2004 100 000	EB .K450H	046	3206 200 000	AB .R800H	075
2005 000 000	EW 3	040	3207 200 000	AB .R800	075
2005 100 000	EW 3	040	3208 000 000	AB .RE700 .4	076
2018 000 000	EW 3 .2	041	3209 000 000	AB .RE700H .2	076
2018 100 000	EW 3 .2	041	3212 000 000	AB .ME500	071
2023 503 000	EB .KE325	048	3213 000 000	AB .ME750	071
2024 503 000	EB .KE375	048	3214 000 000	AB .ME1000	072
2025 503 000	EB .KE400	049	3220 000 000	AB .KE325	068
2100 000 000	EB .0425	050	3221 000 000	AB .KE375	069
2100 100 000	EB .0425	050			

## Article index

Article	Name	Page	Article	Name	Page
3222 000 000	AB . KE400	069	3901 000 093	SB . Aqua360	086
3230 700 000	AB . SR650	073	3902 000 081	SB . Terra450	089
3231 600 000	AB . SR650H	073	3902 000 082	SB . Terra450	089
3302 000 000	AB . Q450 . 1	077	3902 000 083	SB . Terra450	089
3304 000 000	AB . Q450H . 1	077	3902 000 084	SB . Terra450	089
3503 000 000	AB . S0450 . 1	070	3902 000 091	SB . Aqua450	087
3509 000 000	AB . S0400 . 1	070	3902 000 092	SB . Aqua450	087
<b>Dish basins</b>			3902 000 093	SB . Aqua450	087
3500 000 000	SB . K300 . GS	080	4503 000 190	WT . RX400K	098
3501 000 000	SB . K360 . GS	080	4506 500 180	WT . RX400 . KE	092
3502 000 000	SB . K450 . GS	081	<b>Washstands</b>		
3507 500 000	SB . SR650	082	4102 000 000	WT . RE1000H . L	134
3508 500 000	SB . C0375	081	4104 000 000	WT . RE1000H . R	135
3520 000 000	SB . 0700 . GS	082	4105 000 000	WT . RE800H	134
<b>Special glazes</b>			4200 000 000	WT . PR585	128
2031 500 190	UB . K400	096	4201 000 000	WT . PR585H	128
2111 500 190	UB . 0525	096	4203 000 000	WT . PR800H	129
3222 000 180	AB . KE400	090	4203 300 000	WT . PR800	129
3222 000 240	AB . KE400	093	4205 000 000	WT . PR800H . L	130
3501 000 180	SB . K360 . GS	091	4205 300 000	WT . PR800 . L	130
3501 000 190	SB . K360 . GS	098	4207 000 000	WT . PR800H . R	131
3501 000 240	SB . K360 . GS	094	4207 300 000	WT . PR800 . R	131
3503 000 180	AB . S0450 . 1	091	4228 000 000	WT . MC450H	116
3503 000 190	AB . S0450 . 1	097	4230 000 000	WT . MC800H	116
3503 000 240	AB . S0450 . 1	094	4231 000 000	WT . MC800H . L	117
3509 000 180	AB . S0400 . 1	090	4232 000 000	WT . MC800H . R	117
3509 000 190	AB . S0400 . 1	097	4236 200 000	WT . IC325H	114
3509 000 240	AB . S0400 . 1	093	4238 200 000	WT . IC600H	114
3521 500 081	SB . SR650	089	4239 200 000	WT . IC600H . L	115
3521 500 082	SB . SR650	089	4240 200 000	WT . IC600H . R	115
3521 500 083	SB . SR650	089	4261 200 000	WT . GR800H	132
3521 500 084	SB . SR650	089	4270 000 000	WT . QS325	120
3521 500 240	SB . SR650	095	4271 000 000	WT . QS325X	121
3900 000 081	SB . Terra300	088	4273 000 000	WT . QS525 . L	123
3900 000 082	SB . Terra300	088	4274 000 000	WT . QS525 . R	124
3900 000 083	SB . Terra300	088	4275 000 000	WT . QS450	122
3900 000 084	SB . Terra300	088	4276 000 000	WT . QS450H	122
3900 000 091	SB . Aqua300	086	4277 000 000	WT . QS325H	120
3900 000 092	SB . Aqua300	086	4278 000 000	WT . QS450HX	121
3900 000 093	SB . Aqua300	086	4279 000 000	WT . QS525H . L	123
3901 000 081	SB . Terra360	088	4280 000 000	WT . QS525H . R	124
3901 000 082	SB . Terra360	088	4281 600 000	WT . SR800H . L	127
3901 000 083	SB . Terra360	088	4282 600 000	WT . SR800H . R	127
3901 000 084	SB . Terra360	088	4287 200 000	WT . GR1250H	132
3901 000 091	SB . Aqua360	086	4288 200 000	WT . GR1250H . L	133
3901 000 092	SB . Aqua360	086	4289 200 000	WT . GR1250H . R	133
			4290 000 000	WT . XS500H . L	125



## Article index

Article	Name	Page	Article	Name	Page
4291 000 000	WT.XS500.L	125	5155 810 000	WP.Folio1	155
4292 000 000	WT.XS500H.R	126	5155 811 000	WP.Folio1	155
4293 000 000	WT.XS500.R	126	5155 813 000	WP.Folio1	155
4295 000 000	WT.XXS450H.L	118	5155 814 000	WP.Folio1	155
4296 000 000	WT.XXS450.L	118	5155 816 000	WP.Folio1	155
4297 000 000	WT.XXS450H.R	119	5156 510 000	WP.Folio4	156
4298 000 000	WT.XXS450.R	119	5156 511 000	WP.Folio4	156
4500 000 000	WT.RX400KH	104	5156 513 000	WP.Folio4	156
4501 000 000	WT.RX325K	104	5156 514 000	WP.Folio4	156
4502 000 000	WT.RX325K	109	5156 516 000	WP.Folio4	156
4503 000 000	WT.RX400K	105	5156 810 000	WP.Folio3	156
4504 000 000	WT.RX400K	109	5156 811 000	WP.Folio3	156
4505 500 000	WT.RX325.KE	107	5156 813 000	WP.Folio3	156
4506 500 000	WT.RX400.KE	107	5156 814 000	WP.Folio3	156
4507 500 000	WT.RX400.CO	106	5156 816 000	WP.Folio3	156
4507 800 000	WT.RX400H.CO	106	5157 510 000	WP.Folio6	157
4508 500 000	WT.RX400.CU	103	5157 511 000	WP.Folio6	157
4508 800 000	WT.RX400H.CU	103	5157 513 000	WP.Folio6	157
4509 500 240	WT.RX400.CR	102	5157 514 000	WP.Folio6	157
4509 800 240	WT.RX400H.CR	102	5157 516 000	WP.Folio6	157
4801 000 000	WT.RX325QS	108	5157 810 000	WP.Folio5	157
4802 000 000	WT.RX325QS	110	5157 811 000	WP.Folio5	157
4804 000 000	WT.RX450QS	108	5157 813 000	WP.Folio5	157
4805 000 000	WT.RX450QS	110	5157 814 000	WP.Folio5	157
5041 000 000	WT.RS325	111	5157 816 000	WP.Folio5	157
5042 500 000	WT.CO400	113	5158 510 000	WP.Folio8	158
5042 800 000	WT.CO400H	113	5158 511 000	WP.Folio8	158
5052 000 000	WT.RS400	111	5158 513 000	WP.Folio8	158
5054 000 000	WT.RS450	112	5158 514 000	WP.Folio8	158
			5158 516 000	WP.Folio8	158
			5158 810 000	WP.Folio7	158
			5158 811 000	WP.Folio7	158
			5158 813 000	WP.Folio7	158
			5158 814 000	WP.Folio7	158
			5158 816 000	WP.Folio7	158
			5159 510 000	WP.Folio10	159
			5159 511 000	WP.Folio10	159
			5159 513 000	WP.Folio10	159
			5159 514 000	WP.Folio10	159
			5159 516 000	WP.Folio10	159
			5159 810 000	WP.Folio9	159
			5159 811 000	WP.Folio9	159
			5159 813 000	WP.Folio9	159
			5159 814 000	WP.Folio9	159
			5159 816 000	WP.Folio9	159
			5161 510 000	WP.Folio12	154
			5161 511 000	WP.Folio12	154
			5161 513 000	WP.Folio12	154
<b>Washplaces</b>					
0613 001 000	SET.WP.PN1	141			
0613 001 081	SET.WP.PN1	141			
0613 001 083	SET.WP.PN1	141			
0613 001 084	SET.WP.PN1	141			
0613 002 000	SET.WP.PN2	141			
0613 002 081	SET.WP.PN2	141			
0613 002 083	SET.WP.PN2	141			
0613 002 084	SET.WP.PN2	141			
5062 800 000	WP.XXS1	142			
5065 800 000	WP.XXS2	142			
5072 800 000	WP.XS1	143			
5075 800 000	WP.XS2	143			
5155 510 000	WP.Folio2	155			
5155 511 000	WP.Folio2	155			
5155 513 000	WP.Folio2	155			
5155 514 000	WP.Folio2	155			
5155 516 000	WP.Folio2	155			

## Article index

Article	Name	Page	Article	Name	Page
5161 514 000	WP.Folio12	154	8270 000 982	AS.400.S	172
5161 516 000	WP.Folio12	154	8270 221 331	AS.400.HT.L	171
5161 810 000	WP.Folio11	154	8270 221 980	AS.400.HT.L	171
5161 811 000	WP.Folio11	154	8270 321 331	AS.400.HT.R	171
5161 813 000	WP.Folio11	154	8270 321 980	AS.400.HT.R	171
5161 814 000	WP.Folio11	154	8271 000 331	AS.600.S	170
5161 816 000	WP.Folio11	154	8271 000 980	AS.600.S	170
5241 000 000	WP.INSERT1	138	8271 140 331	AS.600.HT	170
5241 000 110	WP.INSERT1	138	8271 140 980	AS.600.HT	170
5242 000 000	WP.INSERT2	138	8272 000 331	AS.800.S	170
5242 000 110	WP.INSERT2	138	8272 000 980	AS.800.S	170
5245 000 000	WP.INSERT5	139	8274 111 981	AS.134.L02	172
5245 000 110	WP.INSERT5	139	8274 111 982	AS.134.L02	172
5256 000 000	WP.PN1	140	8274 112 981	AS.225.L03	172
5256 000 081	WP.PN1	140	8274 112 982	AS.225.L03	172
5256 000 083	WP.PN1	140	8274 170 981	AS.160.TPH	172
5256 000 084	WP.PN1	140	8274 170 982	AS.160.TPH	172
5257 000 000	WP.PN2	140			
5257 000 081	WP.PN2	140	<b>Design mirrors</b>		
5257 000 083	WP.PN2	140	6740 001 331	SP.FR375.S1	176
5257 000 084	WP.PN2	140	6740 001 899	SP.FR375.S1	176
5260 000 000	WP.S19.1	144	6741 001 331	SP.FR450.S1	176
5261 000 000	WP.S19L.1	145	6741 001 899	SP.FR450.S1	176
5262 000 000	WP.S19L.2	146	6742 001 331	SP.FR500.S1	176
5266 000 000	WP.S19.1R	144	6742 001 899	SP.FR500.S1	176
5267 000 000	WP.S19L.1R	145	6743 001 331	SP.FR600.S1	177
5268 000 000	WP.S19L.2R	146	6743 001 899	SP.FR600.S1	177
5270 000 000	WP.WF100.1	149	6744 001 331	SP.FR600.R1	178
5271 000 000	WP.WF20.1	147	6744 001 899	SP.FR600.R1	178
5272 000 000	WP.WF20.2	147	6745 001 331	SP.FR750.R1	178
5273 000 000	WP.WF20.3	148	6745 001 899	SP.FR750.R1	178
5274 000 000	WP.WF20.4	148	6746 001 331	SP.FR1000.R1	178
			6746 001 899	SP.FR1000.R1	178
<b>Bucket sinks</b>			<b>Lights</b>		
1100 000 000	AG.Stahlform505	166	8011 001 978	LE.2*	181
1200 000 000	AG.Stahlform510Ü	166	8012 001 978	LE.3*	181
1205 000 180	AG.Stahlform510Ü	166			
1300 000 000	AG.CONTRA505	167	<b>Mirrors</b>		
8901 000 722	Alurost	167	6716 000 899	SP.325	182
8902 000 980	UTENSIL0	166	6717 000 899	SP.450	183
<b>Assist Shelves</b>			6719 000 899	SP.300	182
8266 000 671	AS.Box1	171	6720 000 899	SP.300C	182
8267 000 671	AS.Box2	171	6736 000 899	SP.2 - 800 mm*	184
8270 000 331	AS.400.S	170	6736 001 899	SP.2 - 1000 mm*	184
8270 000 980	AS.400.S	170	6736 002 899	SP.2 - 1200 mm*	184
8270 000 981	AS.400.S	172			

\* not available in GB

## Article index

Article	Name	Page
<b>Accessories for washplaces of the Folio series</b>		
6323 690 010	HS . F01250 . R	160
6323 690 011	HS . F01250 . R	160
6323 690 013	HS . F01250 . R	160
6323 690 014	HS . F01250 . R	160
6323 690 016	HS . F01250 . R	160
6323 990 010	HS . F01250 . L	160
6323 990 011	HS . F01250 . L	160
6323 990 013	HS . F01250 . L	160
6323 990 014	HS . F01250 . L	160
6323 990 016	HS . F01250 . L	160
8400 057 667	FU . H358 . 1	162
8400 058 667	FU . H358 . 2	162
8400 059 667	FU . H408 . 1	162
8400 060 668	FU . TI1	162
8400 061 668	FU . BX1	163
8400 062 668	FU . BX2	163
8400 063 669	FU . TB1	163

### Accessories for washplaces of the Work.Frame series

8112 000 980	SV . WF100 . 1	150
8112 999 980	SV . WF100 . 1R	151
8113 000 980	SV . WF20 . 1 . 2	150
8113 999 980	SV . WF20 . 1 . 2R	150
8114 000 980	SV . WF20 . 3 . 4	150

### Accessories for basins, washstands and washplaces

8110 000 978	EV . 3	187
8302 000 978	VT . 1	187
8304 000 000	VT . 2	188
8304 000 978	VT . 2	188
8305 000 000	VT . 3	188
8305 000 978	VT . 3	188
8306 000 978	SI . 2	187
8312 000 331	SI . 3	187
8312 000 978	SI . 3	187
8312 000 980	SI . 3	187
8319 000 000	VT . 4	188
8320 000 000	VT . 5	188
8320 000 978	VT . 5	188
8321 000 330	UR . 1	189
8321 000 331	UR . 1	189
8321 000 980	UR . 1	189
9500 280 000	Overflow set B.1	189
9500 410 000	Overflow set C	189

### Spare parts for basins, washstands and washplaces

You can find the spare parts on pages 190 and 191.

# Alape installation procedures

With regards to systematic variety, Alape's extensive range remains unsurpassed. It includes built-in basins, undermount and semi-recessed basins, flush-mounted basins as well as sit-on and dish basins. These small, subtle differences allow Alape to set accents in bathroom design.

## UB Undermount basins



### Installation from below

Classic undermounting variant; with its integrating character, it creates a harmonious overall impression at the washplace. — Material-specific special sets are not required for assembly. It can be installed in all standard counter top materials and thicknesses.

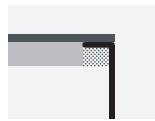

### Undermounting in HPL-coated counter tops

Filigree special solution for installation underneath counter tops coated with HPL (high pressure laminate). — Sealing takes place with a sealing material to be chosen by the fitter. The basin edge is adhered directly under the HPL and the cut-out filled from below with cast resin.

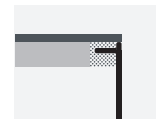

### Undermounting basins with 3 mm edge in HPL-coated counter tops

Undermounting basin variant with 3 mm edge directly below the HPL layer. — Sealing takes place with a sealing material to be chosen by the fitter. The basin edge is adhered directly under the HPL and the cut-out filled from below with cast resin.

## EB Built-in basins



### Installation from above

The most traditional and widespread installation solution. Distinctive edge defines the basin above the counter top. — Assembly and sealing take place in a straightforward and fast manner using a polystyrene ring located on the basin edge, supplied adhesive, and in some cases additional mechanical bracket elements. — It can be installed in all modern counter top materials up to a max. thickness of 40 mm.

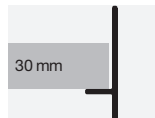

### Built-in basins with 3 mm edge

Filigree Alape special solution for basins with 3 mm wall thickness. With a basin edge protruding 25 mm beyond the counter as standard in the series. — Sealing takes place with a sealing material to be chosen by the fitter, which should be coordinated with the counter top in terms of colour. — It can be installed in all mineral-bound, 30 mm-thick counter top materials.

## AB / SB Sit-on and dish basins



### Traditional sit-on basins

Classic installation variant, lending the basin a dominant character at the washplace. — Classic mechanical assembly using the supplied mounting set. — It can be installed in all standard counter top materials from 12 to 40 mm thickness.

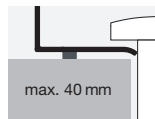

### Sit-on basins with 3 mm edge

Filigree basin variant for the sit-on basin with a mere 3 mm-thick edge. A spacer ring under the basin underscores the filigree shape and simplifies cleaning. — Mounting is straightforward thanks to the supplied shaft valve that can be adjusted to the counter thickness flexibly. — It can be installed in all standard counter top materials from 12 to 40 mm thickness.



Unisono  
Sit-on basins with 3 mm edge  
**AB.KE400**  
ø 400 x 116 mm

## Glazed steel: A material with many talents.

With “A” form”, we have gone from producing washing jugs and bowls over 125 years ago to one of the most diverse ranges of basins and washstands in the sanitary sector.

Besides the huge range of variants with regard to design and assembly, our basins and washstands made from glazed steel offer further benefits resulting from the material. In day-to-day use, you benefit from these positive characteristics.



### Surface Glazed Steel

In the glaze firing, an almost pore-free surface of glass-smooth quality is created, on which neither microorganisms nor dirt particles can find a hold. In addition, the surface does not become statically charged and does not attract dust. This makes our surfaces very easy to care for and hygienic.

### Alape ProShield surface : additional protection against bacteria and fungi

The surface of the glazed steel frees itself from bacteria and fungi thanks to the addition of silver ions. It acts like a protective shield. Our white basins and washstands are equipped with the ProShield surface as standard.

### Resistant to impacts, scratches and abrasions

The glaze, a wafer-thin skin up to a maximum of 300 µm, is immune to external influences. Thin and robust, the glaze deals with the day-to-day household challenges thanks to its mechanical resistance. Therefore, it is a rare occurrence for scratch marks, abrasions or flaking to arise.

### Colorfast and resistant to UV light

Our basin and washstand colors do not fade, regardless of how intensive your shade of color is. This is due to the specific pigments in the glaze, which do not adopt their final color until the firing process. After this, the glaze is perfectly protected against all types of influences.



### Stable shape

Our basins and washstands enjoy a tolerance of +2/-0 millimeters. With intricate manufacturing from the titanium reinforced steel and fired at 830 degrees Celsius, Alape basins always retain their shape and withstand external influences such as varying temperatures and mechanical loads.

### Lightness

Traditionally, our basins and washstands have wall thicknesses between 1.5 and 3 millimetres. Therefore, they are significantly lighter than equivalent products made from other materials.

### Resistant to heat and cold

The glaze is fired into the steel at 830 degrees Celsius and withstands temperature differences of between -60 and +450 degrees Celsius. Even temperature shocks, in other words sudden effects of heat and cold, cannot harm the material.

### Resistant to acids and chemicals

Our glazing has the same acid resistance as glass, meaning that hydrofluoric acid could damage the surface long-term. This is based upon glass-forming oxides, which fuse with the steel during the firing process as a protective coating.



# Made-to-measure washplaces

Irrespective of the construction task at hand, we can adjust our products to meet a project's requirements above and beyond the series standard in terms of colour, dimensions and functionality. Our washstands can be practically freely configured in respect of width, depth and height. Owing to their structural design, functional elements can be integrated too, such as rubbish flaps, lotion, cosmetic or paper towel dispensers, and towel holders.

We can implement washplaces in tight or complex room situations, such as close to doors, with oblique sections and notches in the washstand; we are pleased to undertake made-to-measure manufacturing for niches. Even in the case of custom specifications, our basins and washstands always retain their precision with a dimension tolerance of a mere  $+2/-0$  millimetre.

Whether it is an extremely small, main or hotel bathroom, semi-public sanitary room or spa area: our abilities go beyond basins and washstands. Combinations with counter tops and furniture programmes form part of our range of services too, as well as realising single or bank designs.



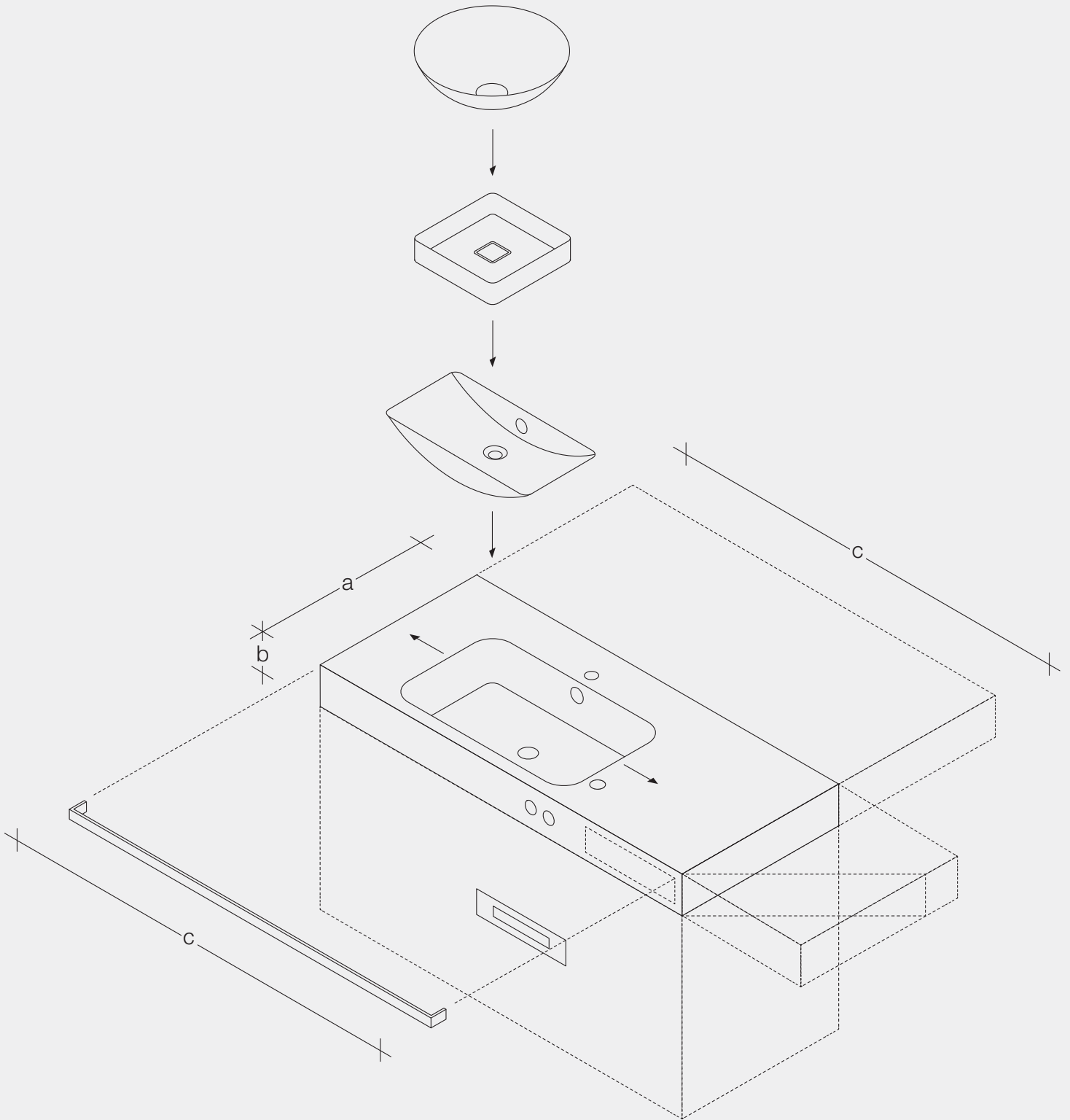

# Individualisation in detail

## **Project-specific solutions for built-in basins**

The edge height can be set variably on built-in basins made from 3 mm glazed steel. The standard here is 25 millimetre edge height above the counter top; however, other overhangs can be set with equally exact precision and stress the basin's filigree shape.

## **Custom-made products**

Sit-on basins can be adjusted to meet project-specific requirements in terms of external height and width dimension; this applies to washstands in terms of depth, width and height.

## **Drill holes**

We can provide custom drill holes in basins and washstands in line with a specification. Not only the bore hole's diameter can be varied, but also its position on the washstand or tap area. Additional drill holes can be integrated upon request too and adjusted in terms of position and diameter.

## **Functional integration**

The design-related benefits of glazed steel enable additional functions to be integrated on a straightforward basis. In this way, paper and cosmetic tissue dispensers can be integrated into washstands or towel holders assembled onto them, for example.

## **Notches and oblique sections**

In complex room situations, tight niches or close to doors, washplaces can be implemented often only with made-to-measure products. Through oblique sections or making notches in corners, we are able to adjust washstands exactly to the millimetre. Therefore, we are able to react together with you to such planning challenges. We can also manufacture fixtures according to your specifications.



**Custom engraving and free colour choice**

Logos or lettering can be engraved to achieve your own custom branding. Our laser engraving is discreet and absolutely lasting in the uppermost glaze layer. We can realise custom colour requests according to RAL right from a quantity of ten basins upwards. According to your specification, our production department can create colour samples from glazed steel for you to choose from and approve.

**Adjusting semi-recessed basins**

To guarantee a harmonious overall appearance, semi built-in basins can be coordinated precisely in terms of their inner radius to suit the radius of the counter top material. Furthermore, the front skirt's height can be varied.



# Tap fitting and drill hole information



Tap fittings with a vertical outlet and aerator provide the optimum flow of water onto the surface below (angle of impact: 90°). We make sure here that the outlet on the stand or wall fitting aligns with the vent in the basin, and that water does not impact to the left or right of the valve cap in the basin. To minimise splashing we also recommend to use a flow restrictor of maximum 7,5l / min. or to reduce the water pressure to maximum 4,5 bar.

With regard to the mounting height of a wall outlet fitting, please observe the respective instructions or recommendations of the manufacturer. The distance between the top edge of the basin and bottom edge of the outlet is normally between 140 to 200 mm.

Please refer to the price list in the product descriptions for information on the optimum water impact area on the basin mould.

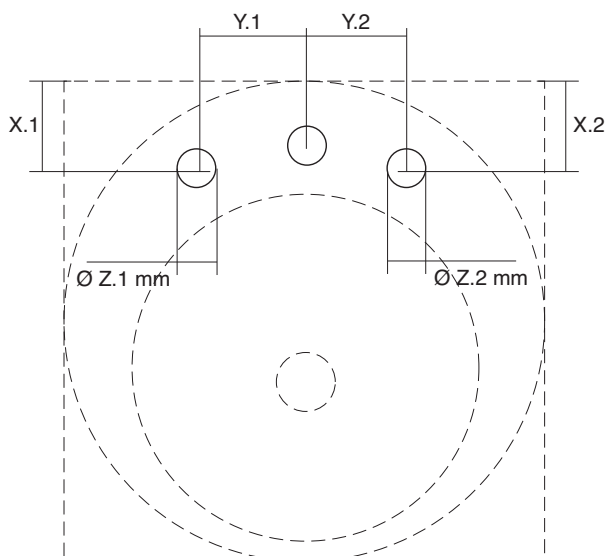

The standard dimensions for tap drill holes is 36 mm according to EN 111. The hole spacing is 100 mm.

All special versions, such as tap hole variants of series products as well as three-hole and lotion dispenser drillings are available on request.

# Technical Information

## **Alape website**

For comprehensive information on our A~form product range, please visit the [www.alape.com](http://www.alape.com). All product documentation and tender specifications planning data are available for download. Use this database to make product specifications quickly and directly.

[www.alape.com](http://www.alape.com)



















# Undermount basins

## **UB**



Undermount basin  
**UB . K450**  
ø 409 x 159mm



Basin width				
325 – 425mm	450 – 585mm	600 – 700mm	750 – 1000mm	
 <p><b>UB . K325</b> Mould ø 284mm Page 24</p>	 <p><b>UB . K450</b> Mould ø 409mm Page 25</p>			Round
 <p><b>UB . K400</b> Mould ø 359mm Page 24</p>	 <p><b>UB . S0450 . 1</b> Mould ø 456/444mm Page 29</p>			
 <p><b>UB . KE325</b> Mould ø 319mm Page 26</p>	 <p><b>UB . S0450 . 2</b> Mould ø 456/444mm Page 30</p>			
 <p><b>UB . KE375</b> Mould ø 369mm Page 27</p>				
 <p><b>UB . KE400</b> Mould ø 394mm Page 28</p>				
 <p><b>UB . 0425</b> Mould 379 x 281mm Page 31</p>	 <p><b>UB . 0525</b> Mould 481 x 383mm Page 31</p>			Oval
	 <p><b>UB . Q450</b> Mould 371 x 371mm Page 37</p>	 <p><b>UB . SR650</b> Mould 609 x 359mm Page 35</p>	 <p><b>UB . ME750</b> Mould 754 x 379mm Page 33</p>	Square and rectangular
	 <p><b>UB . ME500</b> Mould 504 x 379mm Page 32</p>	 <p><b>UB . RE700 . 4</b> Mould 645 x 343mm Page 36</p>	 <p><b>UB . R800</b> Mould 703 x 360mm Page 36</p>	
	 <p><b>UB . R585</b> Mould 507 x 273mm Page 35</p>		 <p><b>UB . ME1000</b> Mould 1004 x 379mm Page 34</p>	

## Undermount basins – K-series

Cut-out dimensions: Download [www.alape.com](http://www.alape.com)

### UB . K325



Undermount basin, round, Ø 284 mm, height 110 mm, glazed steel, without tap hole, with overflow, included fixing set, overflow set

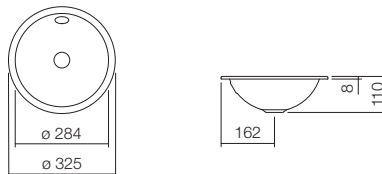

	Art. No.
white, ProShield	2030 700 000

Version
Without overflow
Glossy, matt, special colour

#### Fittings information

Impact area approx. 85 – 115 mm from rear edge of basin.  
For parameters, see page 20.

Recommended miscellaneous	Art. No.
Bottle trap, Sl.2	8306 000 978
Bottle trap, Sl.3	8312 000 978
Drain valve, VT.1	8302 000 978

### UB . K400



Undermount basin, round, Ø 359 mm, height 140 mm, glazed steel, without tap hole, with overflow, included fixing set, overflow set

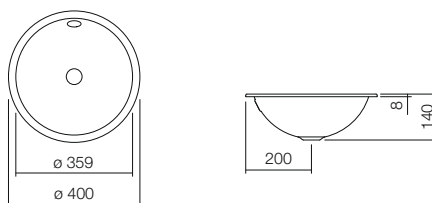

	Art. No.
white, ProShield	2031 700 000

Version
Without overflow
Glossy, matt, special colour

#### Fittings information

Impact area approx. 110 – 150 mm from rear edge of basin.  
For parameters, see page 20.

Recommended miscellaneous	Art. No.
Bottle trap, Sl.2	8306 000 978
Bottle trap, Sl.3	8312 000 978
Drain valve, VT.1	8302 000 978



## Undermount basins – K-series

Cut-out dimensions: Download [www.alape.com](http://www.alape.com)

### UB . K450



Undermount basin, round, Ø 409 mm, height 159 mm, glazed steel, without tap hole, with overflow, included fixing set, overflow set

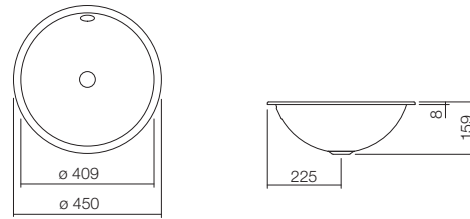

	Art. No.
white, ProShield	2032 700 000

Version
Without overflow
Glossy, matt, special colour

#### Fittings information

Impact area approx. 110 – 170 mm from rear edge of basin.  
For parameters, see page 20.

Recommended miscellaneous	Art. No.
Bottle trap, SI.2	8306 000 978
Bottle trap, SI.3	8312 000 978
Drain valve, VT.1	8302 000 978

**Undermount basins – KE-series (Unisono)**Cut-out dimensions: Download [www.alape.com](http://www.alape.com)**UB . KE325**

Undermount basin, round, Ø 319 mm, height 104 mm, glazed steel, without tap hole, without overflow, included fixing set, drain valve, valve cap, chrome-plated, Ø 63 mm

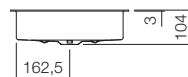
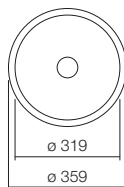

	<b>Art. No.</b>
white, ProShield	3223 501 000

<b>Version</b>	
Glossy, matt, special colour	

**Fittings information**

Impact area approx. 102 – 137 mm from rear edge of basin.  
For parameters, see page 20.

**Recommended miscellaneous**

Bottle trap, Sl.2  
Bottle trap, Sl.3

**Art. No.**

8306 000 978  
8312 000 978

**UB . KE325**

Undermount basin, round, Ø 319 mm, height 104 mm, glazed steel, without tap hole, without overflow, included fixing set, drain valve, valve cap, chrome-plated, Ø 63 mm, optimised for installation directly under the laminate layer of a coated counter top

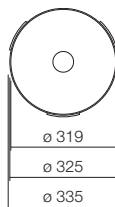

	<b>Art. No.</b>
white, ProShield	3223 504 000

<b>Version</b>	
Glossy, matt, special colour	

**Fittings information**

Impact area approx. 102 – 137 mm from rear edge of basin.  
For parameters, see page 20.

**Recommended miscellaneous**

Bottle trap, Sl.2  
Bottle trap, Sl.3

**Art. No.**

8306 000 978  
8312 000 978

**Undermount basins – KE-series (Unisono)**Cut-out dimensions: Download [www.alape.com](http://www.alape.com)**UB . KE375**

Undermount basin, round, Ø 369 mm, height 114 mm, glazed steel, without tap hole, without overflow, included fixing set, drain valve, valve cap, chrome-plated, Ø 74 mm

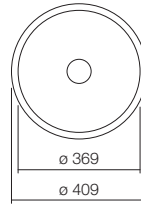

	<b>Art. No.</b>
white, ProShield	3224 501 000

<b>Version</b>	
Glossy, matt, special colour	

**Fittings information**

Impact area approx. 117 – 162 mm from rear edge of basin.  
For parameters, see page 20.

<b>Recommended miscellaneous</b>	<b>Art. No.</b>
Bottle trap, Sl.2	8306 000 978
Bottle trap, Sl.3	8312 000 978

**UB . KE375**

Undermount basin, round, Ø 369 mm, height 114 mm, glazed steel, without tap hole, without overflow, included fixing set, drain valve, valve cap, chrome-plated, Ø 74 mm, optimised for installation directly under the laminate layer of a coated counter top

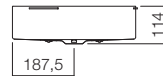
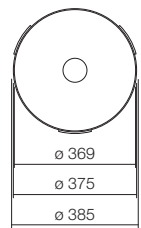

	<b>Art. No.</b>
white, ProShield	3224 504 000

<b>Version</b>	
Glossy, matt, special colour	

**Fittings information**

Impact area approx. 117 – 162 mm from rear edge of basin.  
For parameters, see page 20.

<b>Recommended miscellaneous</b>	<b>Art. No.</b>
Bottle trap, Sl.2	8306 000 978
Bottle trap, Sl.3	8312 000 978

**Undermount basins – KE-series (Unisono)**Cut-out dimensions: Download [www.alape.com](http://www.alape.com)**UB . KE400**

Undermount basin, round, Ø 394 mm, height 114 mm, glazed steel, without tap hole, without overflow, included fixing set, drain valve, valve cap, chrome-plated, Ø 74 mm

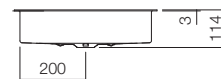
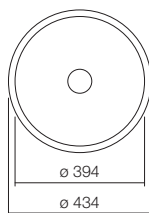

	<b>Art. No.</b>
white, ProShield	3225 501 000

<b>Version</b>	
Glossy, matt, special colour	

**Fittings information**

Impact area approx. 122 – 167 mm from rear edge of basin.  
For parameters, see page 20.

**Recommended miscellaneous**

Bottle trap, Sl.2  
Bottle trap, Sl.3

**Art. No.**

8306 000 978  
8312 000 978

**UB . KE400**

Undermount basin, round, Ø 394 mm, height 114 mm, glazed steel, without tap hole, without overflow, included fixing set, drain valve, valve cap, chrome-plated, Ø 74 mm, optimised for installation directly under the laminate layer of a coated counter top

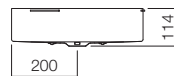
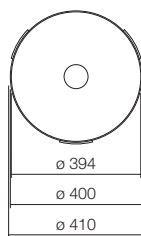

	<b>Art. No.</b>
white, ProShield	3225 504 000

<b>Version</b>	
Glossy, matt, special colour	

**Fittings information**

Impact area approx. 122 – 167 mm from rear edge of basin.  
For parameters, see page 20.

**Recommended miscellaneous**

Bottle trap, Sl.2  
Bottle trap, Sl.3

**Art. No.**

8306 000 978  
8312 000 978

## Undermount basins – SO-series (Sondo)

Cut-out dimensions: Download [www.alape.com](http://www.alape.com)

### UB . S0450 . 1



Undermount basin, round, Ø 456 mm, height 115 mm, glazed steel, without tap hole, without overflow, included fixing set, drain valve, valve cap, chrome-plated, Ø 74 mm

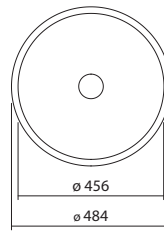

#### Art. No.

white, ProShield

3505 501 000

#### Version

Glossy, matt, special colour

#### Fittings information

Impact area approx. 77 – 187 mm from rear edge of basin.  
For parameters, see page 20.

#### Recommended miscellaneous

Bottle trap, Sl.2  
Bottle trap, Sl.3

#### Art. No.

8306 000 978  
8312 000 978

### UB . S0450 . 1



Undermount basin, round, Ø 444 mm, height 115 mm, glazed steel, without tap hole, without overflow, included fixing set, drain valve, valve cap, chrome-plated, Ø 74 mm, optimised for installation directly under the laminate layer of a coated counter top

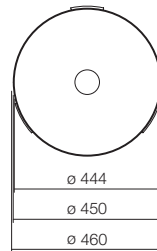

#### Art. No.

white, ProShield

3505 504 000

#### Version

Glossy, matt, special colour

#### Fittings information

Impact area approx. 77 – 187 mm from rear edge of basin.  
For parameters, see page 20.

#### Recommended miscellaneous

Bottle trap, Sl.2  
Bottle trap, Sl.3

#### Art. No.

8306 000 978  
8312 000 978

**Undermount basins – SO-series (Sondo)**Cut-out dimensions: Download [www.alape.com](http://www.alape.com)**UB . S0450 . 2**

Undermount basin, round, Ø 456 mm, height 145 mm, glazed steel, without tap hole, without overflow, included fixing set, drain valve, valve cap, chrome-plated, Ø 74 mm

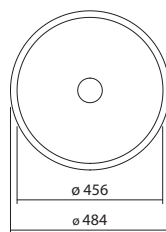
**Art. No.**

white, ProShield

3506 501 000

**Version**

Glossy, matt, special colour

**Fittings information**

Impact area approx. 77 – 187 mm from rear edge of basin.  
For parameters, see page 20.

**Recommended miscellaneous**

Bottle trap, Sl.2  
Bottle trap, Sl.3

**Art. No.**

8306 000 978  
8312 000 978

**UB . S0450 . 2**

Undermount basin, round, Ø 444 mm, height 145 mm, glazed steel, without tap hole, without overflow, included fixing set, drain valve, valve cap, chrome-plated, Ø 74 mm, optimised for installation directly under the laminate layer of a coated counter top

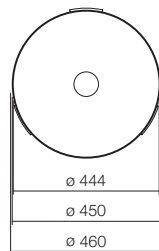
**Art. No.**

white, ProShield

3506 504 000

**Version**

Glossy, matt, special colour

**Fittings information**

Impact area approx. 77 – 187 mm from rear edge of basin.  
For parameters, see page 20.

**Recommended miscellaneous**

Bottle trap, Sl.2  
Bottle trap, Sl.3

**Art. No.**

8306 000 978  
8312 000 978

## Undermount basins – O-series

Cut-out dimensions: Download [www.alape.com](http://www.alape.com)

### UB . 0425



Undermount basin, oval, w/h/d 379/110/281 mm, glazed steel, without tap hole, with overflow, included fixing set, overflow set

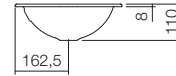
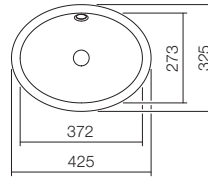

#### Art. No.

white, ProShield

2110 700 000

#### Version

Without overflow  
Glossy, matt, special colour

#### Fittings information

Impact area approx. 100 – 125 mm from rear edge of basin.  
For parameters, see page 20.

#### Recommended miscellaneous

Bottle trap, Sl.2  
Bottle trap, Sl.3  
Drain valve, VT.1

#### Art. No.

8306 000 978  
8312 000 978  
8302 000 978

### UB . 0525



Undermount basin, oval, w/h/d 481/150/383 mm, glazed steel, without tap hole, with overflow, included fixing set, overflow set

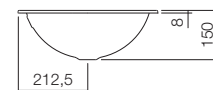
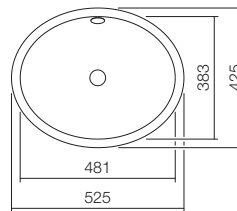

#### Art. No.

white, ProShield

2111 700 000

#### Version

Without overflow  
Glossy, matt, special colour

#### Fittings information

Impact area approx. 120 – 165 mm from rear edge of basin.  
For parameters, see page 20.

#### Recommended miscellaneous

Bottle trap, Sl.2  
Bottle trap, Sl.3  
Drain valve, VT.1

#### Art. No.

8306 000 978  
8312 000 978  
8302 000 978

**Undermount basins – ME-series (Metaphor)**

Cut-out dimensions: Download [www.alape.com](http://www.alape.com)

**UB . ME500**

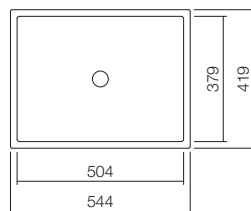

Undermount basin, rectangular, w/h/d 504/111/379 mm, glazed steel, without tap hole, with overflow, included fixing set, overflow set



**Art. No.**

white, ProShield

3226 701 000

**Version**

Without overflow  
Glossy, matt, special colour

**Fittings information**

Impact area approx. 112 – 157 mm from rear edge of basin.  
For parameters, see page 20.

**Recommended miscellaneous**

Bottle trap, Sl.2  
Bottle trap, Sl.3  
Drain valve, VT.1

**Art. No.**

8306 000 978  
8312 000 978  
8302 000 978

**UB . ME500**

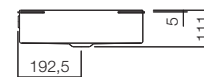
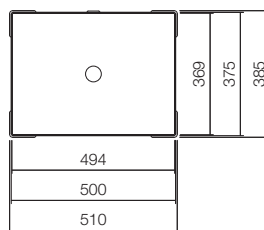

Undermount basin, rectangular, w/h/d 494/111/369 mm, glazed steel, without tap hole, with overflow, included fixing set, overflow set, optimised for installation directly under the laminate layer of a coated counter top



**Art. No.**

white, ProShield

3226 704 000

**Version**

Without overflow  
Glossy, matt, special colour

**Fittings information**

Impact area approx. 112 – 157 mm from rear edge of basin.  
For parameters, see page 20.

**Recommended miscellaneous**

Bottle trap, Sl.2  
Bottle trap, Sl.3  
Drain valve, VT.1

**Art. No.**

8306 000 978  
8312 000 978  
8302 000 978



## Undermount basins – ME-series (Metaphor)

Cut-out dimensions: Download [www.alape.com](http://www.alape.com)

### UB . ME750



Undermount basin, rectangular, w/h/d 754/111/379 mm, glazed steel, without tap hole, with overflow, included fixing set, overflow set

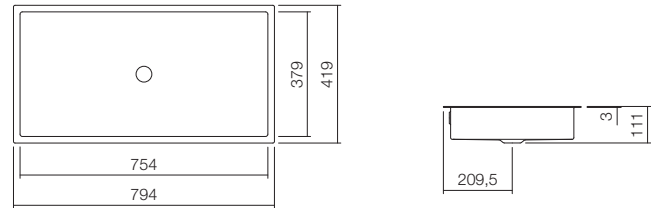

Art. No.
white, ProShield
3227 701 000

Version
Without overflow
Glossy, matt, special colour

#### Fittings information

Impact area approx. 112 – 157 mm from rear edge of basin.  
For parameters, see page 20.

#### Recommended miscellaneous

Bottle trap, Sl.2  
Bottle trap, Sl.3  
Drain valve, VT.1

#### Art. No.

8306 000 978  
8312 000 978  
8302 000 978

### UB . ME750



Undermount basin, rectangular, w/h/d 744/111/369 mm, glazed steel, without tap hole, with overflow, included fixing set, overflow set, optimised for installation directly under the laminate layer of a coated counter top

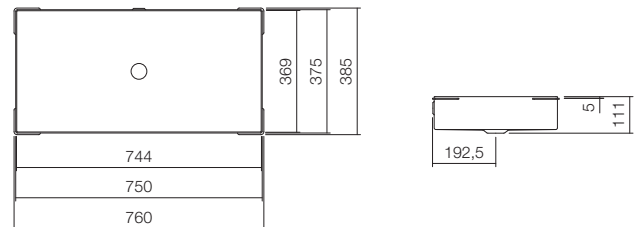

Art. No.
white, ProShield
3227 704 000

Version
Without overflow
Glossy, matt, special colour

#### Fittings information

Impact area approx. 112 – 157 mm from rear edge of basin.  
For parameters, see page 20.

#### Recommended miscellaneous

Bottle trap, Sl.2  
Bottle trap, Sl.3  
Drain valve, VT.1

#### Art. No.

8306 000 978  
8312 000 978  
8302 000 978

**Undermount basins – ME-series (Metaphor)**Cut-out dimensions: Download [www.alape.com](http://www.alape.com)**UB . ME1000**

Undermount basin, rectangular, w/h/d 1004/111/379 mm, glazed steel, without tap hole, with overflow, included fixing set, overflow set

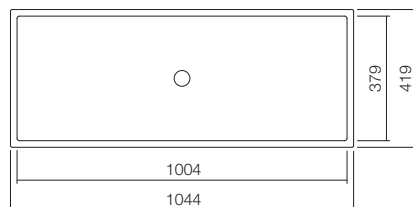
**Art. No.**

white, ProShield

3228 701 000

**Version**

Without overflow  
Glossy, matt, special colour

**Fittings information**

Impact area approx. 112 – 157 mm from rear edge of basin.  
For parameters, see page 20.

**Recommended miscellaneous**

Bottle trap, Sl.2  
Bottle trap, Sl.3  
Drain valve, VT.1

**Art. No.**

8306 000 978  
8312 000 978  
8302 000 978

**UB . ME1000**

Undermount basin, rectangular, w/h/d 994/111/369 mm, glazed steel, without tap hole, with overflow, included fixing set, overflow set, optimised for installation directly under the laminate layer of a coated counter top

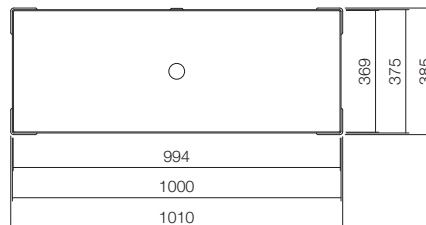
**Art. No.**

white, ProShield

3228 704 000

**Version**

Without overflow  
Glossy, matt, special colour

**Fittings information**

Impact area approx. 112 – 157 mm from rear edge of basin.  
For parameters, see page 20.

**Recommended miscellaneous**

Bottle trap, Sl.2  
Bottle trap, Sl.3  
Drain valve, VT.1

**Art. No.**

8306 000 978  
8312 000 978  
8302 000 978

## Undermount basins – SR-series, R-series

Cut-out dimensions: Download [www.alape.com](http://www.alape.com)

### UB . SR650



Undermount basin, rectangular, w/h/d 609/127/359 mm, glazed steel, without tap hole, with overflow, included fixing set, overflow set

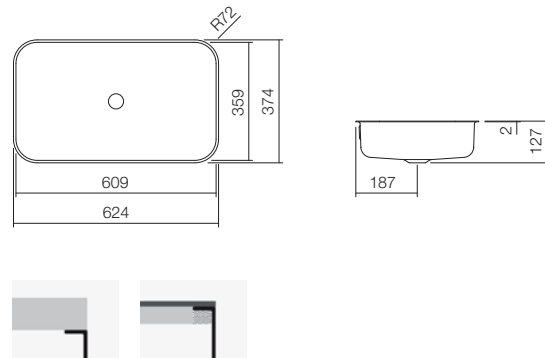

Art. No.
white, ProShield
2255 700 000

Version
Without overflow
Glossy, matt, special colour

#### Fittings information

Impact area approx. 70 – 120 mm from rear edge of basin.  
For parameters, see page 20.

Recommended miscellaneous	Art. No.
Bottle trap, Sl.2	8306 000 978
Bottle trap, Sl.3	8312 000 978
Drain valve, VT.1	8302 000 978

### UB . R585



Undermount basin, rectangular, w/h/d 507/143/274 mm, glazed steel, without tap hole, with overflow, included fixing set, overflow set

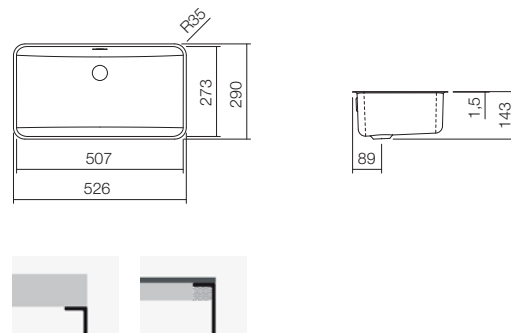

Art. No.
white, ProShield
2250 700 000

Version
Without overflow
Glossy, matt, special colour

#### Fittings information

Impact area approx. 133 – 153 mm from rear edge of basin.  
For parameters, see page 20.

Recommended miscellaneous	Art. No.
Bottle trap, Sl.2	8306 000 978
Bottle trap, Sl.3	8312 000 978
Drain valve, VT.1	8302 000 978

**Undermount basins – R-series, RE-series**

Cut-out dimensions: Download [www.alape.com](http://www.alape.com)

**UB . R800**



Undermount basin, rectangular, w/h/d 703/120/353 mm, glazed steel, without tap hole, with overflow, included fixing set, overflow set

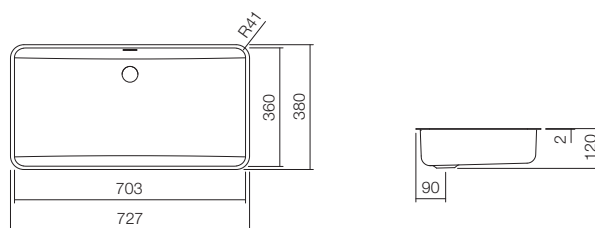

**Art. No.**

white, ProShield

2251 700 000

**Version**

Without overflow  
Glossy, matt, special colour

**Fittings information**

Impact area approx. 145.5 – 200.5 mm from rear edge of basin.  
For parameters, see page 20.

**Recommended miscellaneous**

Bottle trap, Sl.2  
Bottle trap, Sl.3  
Drain valve, VT.1

**Art. No.**

8306 000 978  
8312 000 978  
8302 000 978

**UB . RE700 . 4**



Undermount basin, rectangular, w/h/d 645/90/343 mm, glazed steel, without tap hole, without overflow, included fixing set, drain valve, valve cap, white glazed, w/d 68/68 mm

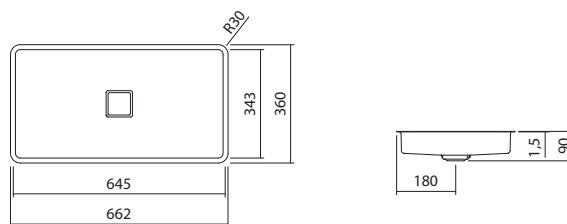

**Art. No.**

white, ProShield

2258 500 000

**Version**

Glossy, matt, special colour

**Fittings information**

Impact area approx. 86 – 121 mm from rear edge of basin.  
For parameters, see page 20.

**Recommended miscellaneous**

Bottle trap, Sl.2  
Bottle trap, Sl.3

**Art. No.**

8306 000 978  
8312 000 978

## Undermount basins – Q-series

Cut-out dimensions: Download [www.alape.com](http://www.alape.com)

### UB . Q450



Undermount basin, square, w/h/d 371/94/371 mm, glazed steel, without tap hole, without overflow, included fixing set, drain valve, valve cap, white glazed, w/d 68/68 mm

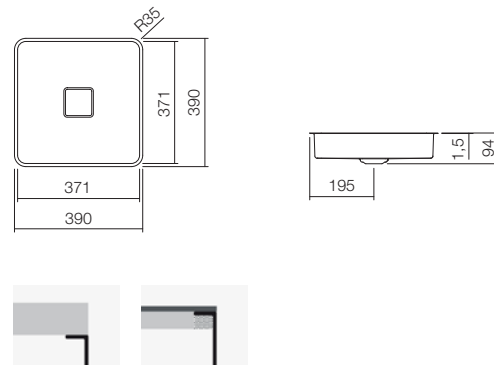

	Art. No.
white, ProShield	2312 500 000

	Version
	Glossy, matt, special colour

#### Fittings information

Impact area approx. 85 – 140 mm from rear edge of basin.  
For parameters, see page 20.





























Recommended miscellaneous	Art. No.
Bottle trap, Sl.2	8306 000 978
Bottle trap, Sl.3	8312 000 978

# Built-in basins

## **EB**



Built-in basin  
**EB . R585H**  
585 x 143 x 405mm

Basin width				
325 – 425mm	450 – 600mm	600 – 700mm	750 – 800mm	
 <p><b>EB.K325</b> ø 325mm I P. 43</p>  <p><b>EB.K400</b> ø 400mm I P. 45</p>  <p><b>EB.K400H</b> ø 400mm I P. 44</p>  <p><b>EB.KE325</b> ø 325mm I P. 48</p>  <p><b>EB.KE375</b> ø 375mm I P. 48</p>  <p><b>EB.KE400</b> ø 400mm I P. 49</p>	 <p><b>EB.K450</b> ø 450mm I P. 47</p>  <p><b>EB.K450H</b> ø 450mm I P. 46</p>  <p><b>EB.S450H</b> ø 450mm I P. 42</p>  <p><b>HB.S450H</b> ø 450mm I P. 63</p>  <p><b>EW 3/EW 3.2</b> ø 475mm I P. 40/41</p>			<b>Round</b>
 <p><b>EB.0425</b> 425 x 325mm I P. 50</p>	 <p><b>EB.0525</b> 525 x 425mm I P. 52</p>  <p><b>EB.0500H</b> 500 x 400mm I P. 51</p>	 <p><b>EB.0600H</b> 600 x 500mm I P. 53</p>		<b>Oval</b>
	 <p><b>EB.Q450</b> 450 x 450mm I P. 62</p>  <p><b>EB.Q450H</b> 450 x 500mm I P. 62</p>  <p><b>EB.ME500</b> 500 x 375mm I P. 54</p>  <p><b>EB.R585</b> 585 x 347mm I P. 58</p>  <p><b>EB.R585H</b> 585 x 405mm I P. 57</p>  <p><b>HB.R585H</b> 585 x 405mm I P. 63</p>	 <p><b>EB.SR650</b> 650 x 415mm I P. 56</p>  <p><b>EB.SR650H</b> 650 x 472mm I P. 55</p>  <p><b>EB.RE700H.2</b> 700 x 460mm I P. 61</p>  <p><b>EB.RE700.4</b> 700 x 398mm I P. 61</p>	 <p><b>EB.ME750</b> 750 x 375mm I P. 54</p>  <p><b>EB.R800</b> 800 x 450mm I P. 60</p>  <p><b>EB.R800H</b> 800 x 500mm I P. 59</p>	<b>Square and rectangular</b>

**Built-in basins – EW-series**Cut-out dimensions: Download [www.alape.com](http://www.alape.com)**EW 3**

Built-in basin, round, Ø 475 mm, height 186 mm, glazed steel, with one tap hole, with overflow, included fixing set, overflow set, PVC seal

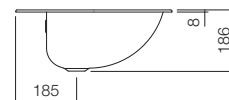
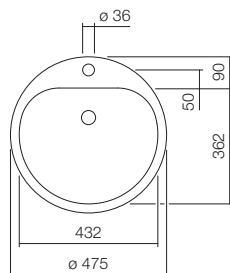

	<b>Art. No.</b>
white, ProShield	2005 000 000

**Version**  
 Without tap hole  
 3 Drill holes  
 Drill hole for lotion dispenser  
 Glossy, matt, special colour

**Fittings information**

Impact area approx. 190 – 270 mm from middle tap hole.  
 For parameters, see page 20.

<b>Recommended miscellaneous</b>	<b>Art. No.</b>
Bottle trap, Sl.2	8306 000 978
Bottle trap, Sl.3	8312 000 978
Drain valve, VT.1	8302 000 978
Angle valve cover, EV.3	8110 000 978

**EW 3**

Built-in basin, round, Ø 475 mm, height 186 mm, glazed steel, with one tap hole, without overflow, included fixing set, PVC seal

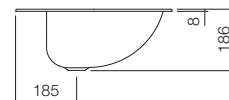
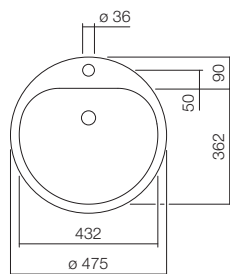

	<b>Art. No.</b>
white, ProShield	2005 100 000

**Version**  
 Without tap hole  
 3 Drill holes  
 Drill hole for lotion dispenser  
 Glossy, matt, special colour

**Fittings information**

Impact area approx. 190 – 270 mm from middle tap hole.  
 For parameters, see page 20.

<b>Recommended miscellaneous</b>	<b>Art. No.</b>
Bottle trap, Sl.2	8306 000 978
Bottle trap, Sl.3	8312 000 978
Drain valve, VT.3	8305 000 000
Angle valve cover, EV.3	8110 000 978



## Built-in basins – EW-series

Cut-out dimensions: Download [www.alape.com](http://www.alape.com)

### EW 3.2



Built-in basin, round, Ø 475 mm, height 186 mm, glazed steel, with one tap hole, with overflow, included fixing set, overflow set

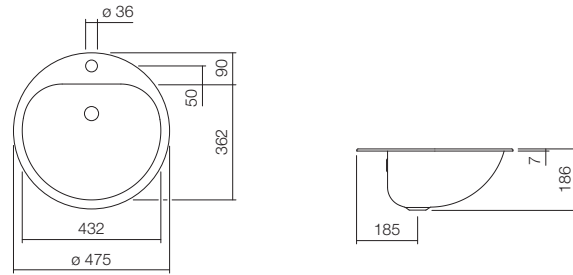

	Art. No.
white, ProShield	2018 000 000

Version
Without tap hole
3 Drill holes
Drill hole for lotion dispenser
Glossy, matt, special colour

#### Fittings information

Impact area approx. 190 – 270 mm from middle tap hole.  
For parameters, see page 20.

Recommended miscellaneous	Art. No.
Bottle trap, Sl.2	8306 000 978
Bottle trap, Sl.3	8312 000 978
Drain valve, VT.1	8302 000 978
Angle valve cover, EV.3	8110 000 978

### EW 3.2



Built-in basin, round, Ø 475 mm, height 186 mm, glazed steel, with one tap hole, without overflow, included fixing set

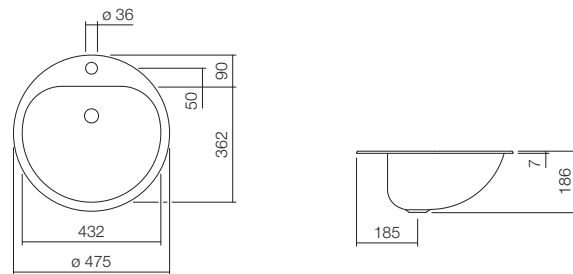

	Art. No.
white, ProShield	2018 100 000

Version
Without tap hole
3 Drill holes
Drill hole for lotion dispenser
Glossy, matt, special colour

#### Fittings information

Impact area approx. 190 – 270 mm from middle tap hole.  
For parameters, see page 20.

Recommended miscellaneous	Art. No.
Bottle trap, Sl.2	8306 000 978
Bottle trap, Sl.3	8312 000 978
Drain valve, VT.3	8305 000 000
Angle valve cover, EV.3	8110 000 978

**Built-in basins – S-series**Cut-out dimensions: Download [www.alape.com](http://www.alape.com)**EB . S450H**

Built-in basin, round, Ø 450 mm, height 163 mm, glazed steel, with one tap hole, with overflow, included fixing set, overflow set

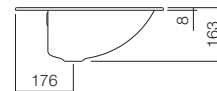
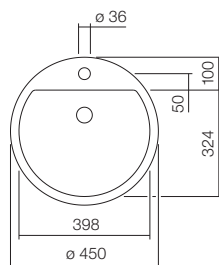

	<b>Art. No.</b>
white, ProShield	2406 000 000

<b>Version</b>
Without tap hole
3 Drill holes
Drill hole for lotion dispenser
Glossy, matt, special colour

<b>Fittings information</b>
Impact area approx. 170 – 210 mm from middle tap hole.
For parameters, see page 20.

<b>Recommended miscellaneous</b>	<b>Art. No.</b>
Bottle trap, Sl.2	8306 000 978
Bottle trap, Sl.3	8312 000 978
Drain valve, VT.1	8302 000 978
Angle valve cover, EV.3	8110 000 978

**EB . S450H**

Built-in basin, round, Ø 450 mm, height 163 mm, glazed steel, with one tap hole, without overflow, included fixing set

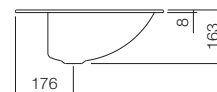
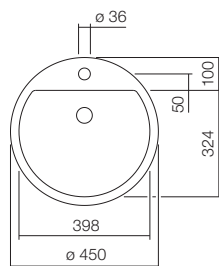

	<b>Art. No.</b>
white, ProShield	2406 100 000

<b>Version</b>
Without tap hole
3 Drill holes
Drill hole for lotion dispenser
Glossy, matt, special colour

<b>Fittings information</b>
Impact area approx. 170 – 210 mm from middle tap hole.
For parameters, see page 20.

<b>Recommended miscellaneous</b>	<b>Art. No.</b>
Bottle trap, Sl.2	8306 000 978
Bottle trap, Sl.3	8312 000 978
Drain valve, VT.3	8305 000 000
Angle valve cover, EV.3	8110 000 978

## Built-in basins – K-series

Cut-out dimensions: Download [www.alape.com](http://www.alape.com)

### EB . K325



Built-in basin, round, Ø 325 mm, height 110 mm, glazed steel, without tap hole, with overflow, included fixing set, overflow set

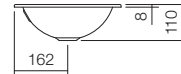
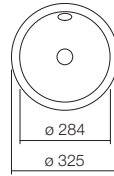

#### Art. No.

white, ProShield

2000 200 000

#### Version

Glossy, matt, special colour

#### Fittings information

Impact area approx. 85 – 115 mm from rear edge of basin.  
For parameters, see page 20.

#### Recommended miscellaneous

Bottle trap, Sl.2  
Bottle trap, Sl.3  
Drain valve, VT.1  
Angle valve cover, EV.3

#### Art. No.

8306 000 978  
8312 000 978  
8302 000 978  
8110 000 978

### EB . K325



Built-in basin, round, Ø 325 mm, height 110 mm, glazed steel, without tap hole, without overflow, included fixing set

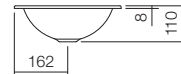
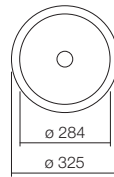

#### Art. No.

white, ProShield

2000 000 000

#### Version

Glossy, matt, special colour

#### Fittings information

Impact area approx. 85 – 115 mm from rear edge of basin.  
For parameters, see page 20.

#### Recommended miscellaneous

Bottle trap, Sl.2  
Bottle trap, Sl.3  
Drain valve, VT.2  
Angle valve cover, EV.3

#### Art. No.

8306 000 978  
8312 000 978  
8304 000 000  
8110 000 978

**Built-in basins – K-series**Cut-out dimensions: Download [www.alape.com](http://www.alape.com)**EB . K400H**

Built-in basin, round, Ø 400 mm, height 110 mm, glazed steel, with one tap hole, with overflow, included fixing set, overflow set

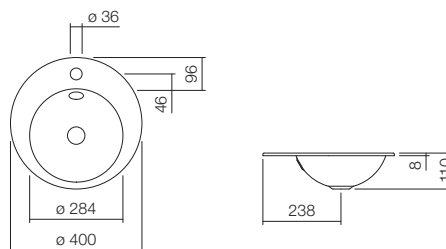
**Art. No.**

white, ProShield

2003 200 000

**Version**

Without tap hole  
3 Drill holes  
Drill hole for lotion dispenser  
Glossy, matt, special colour

**Fittings information**

Impact area approx. 110 – 140 mm from middle tap hole.  
For parameters, see page 20.

**Recommended miscellaneous****Art. No.**

Bottle trap, Sl.2	8306 000 978
Bottle trap, Sl.3	8312 000 978
Drain valve, VT.1	8302 000 978
Angle valve cover, EV.3	8110 000 978

**EB . K400H**

Built-in basin, round, Ø 400 mm, height 110 mm, glazed steel, with one tap hole, without overflow, included fixing set

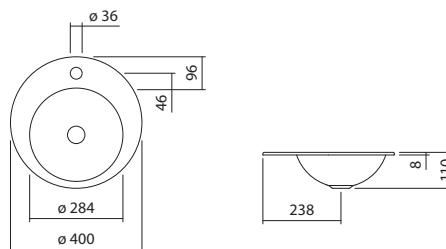
**Art. No.**

white, ProShield

2003 000 000

**Version**

Without tap hole  
3 Drill holes  
Drill hole for lotion dispenser  
Glossy, matt, special colour

**Fittings information**

Impact area approx. 110 – 140 mm from middle tap hole.  
For parameters, see page 20.

**Recommended miscellaneous****Art. No.**

Bottle trap, Sl.2	8306 000 978
Bottle trap, Sl.3	8312 000 978
Drain valve, VT.2	8304 000 000
Angle valve cover, EV.3	8110 000 978

## Built-in basins – K-series

Cut-out dimensions: Download [www.alape.com](http://www.alape.com)

### EB . K400



Built-in basin, round, Ø 400 mm, height 140 mm, glazed steel, without tap hole, with overflow, included fixing set, overflow set

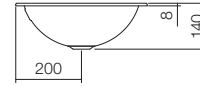
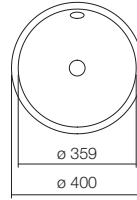

#### Art. No.

white, ProShield

2001 000 000

#### Version

Glossy, matt, special colour

#### Fittings information

Impact area approx. 110 – 150 mm from rear edge of basin.  
For parameters, see page 20.

#### Recommended miscellaneous

Bottle trap, Sl.2  
Bottle trap, Sl.3  
Drain valve, VT.1  
Angle valve cover, EV.3

#### Art. No.

8306 000 978  
8312 000 978  
8302 000 978  
8110 000 978

### EB . K400



Built-in basin, round, Ø 400 mm, height 140 mm, glazed steel, without tap hole, without overflow, included fixing set

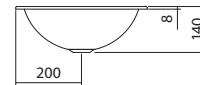
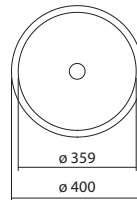

#### Art. No.

white, ProShield

2001 100 000

#### Version

Glossy, matt, special colour

#### Fittings information

Impact area approx. 110 – 150 mm from rear edge of basin.  
For parameters, see page 20.

#### Recommended miscellaneous

Bottle trap, Sl.2  
Bottle trap, Sl.3  
Drain valve, VT.3  
Angle valve cover, EV.3

#### Art. No.

8306 000 978  
8312 000 978  
8305 000 000  
8110 000 978

**Built-in basins – K-series**Cut-out dimensions: Download [www.alape.com](http://www.alape.com)**EB . K450H**

Built-in basin, round, Ø 450 mm, height 129 mm, glazed steel, with one tap hole, with overflow, included fixing set, overflow set

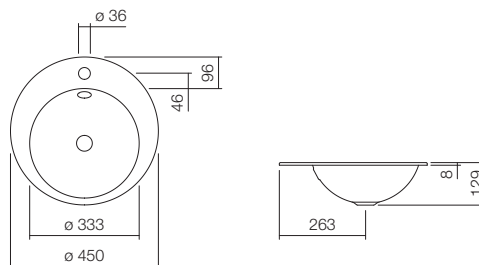

	<b>Art. No.</b>
white, ProShield	2004 000 000

<b>Version</b>
Without tap hole
3 Drill holes
Drill hole for lotion dispenser
Glossy, matt, special colour

<b>Fittings information</b>
Impact area approx. 140 – 160 mm from middle tap hole.
For parameters, see page 20.

<b>Recommended miscellaneous</b>	<b>Art. No.</b>
Bottle trap, Sl.2	8306 000 978
Bottle trap, Sl.3	8312 000 978
Drain valve, VT.1	8302 000 978
Angle valve cover, EV.3	8110 000 978

**EB . K450H**

Built-in basin, round, Ø 450 mm, height 129 mm, glazed steel, with one tap hole, without overflow, included fixing set

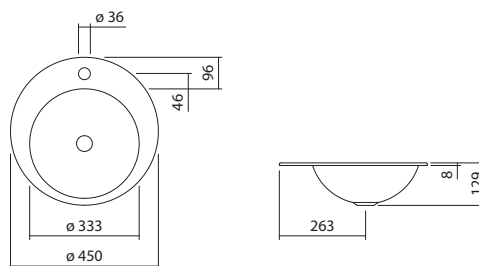

	<b>Art. No.</b>
white, ProShield	2004 100 000

<b>Version</b>
Without tap hole
3 Drill holes
Drill hole for lotion dispenser
Glossy, matt, special colour

<b>Fittings information</b>
Impact area approx. 140 – 160 mm from middle tap hole.
For parameters, see page 20.

<b>Recommended miscellaneous</b>	<b>Art. No.</b>
Bottle trap, Sl.2	8306 000 978
Bottle trap, Sl.3	8312 000 978
Drain valve, VT.3	8305 000 000
Angle valve cover, EV.3	8110 000 978

## Built-in basins – K-series

Cut-out dimensions: Download [www.alape.com](http://www.alape.com)

### EB . K450



Built-in basin, round, Ø 450 mm, height 159 mm, glazed steel, without tap hole, with overflow, included fixing set, overflow set

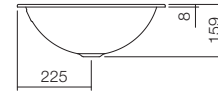
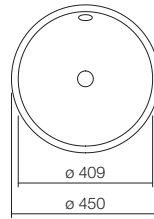

#### Art. No.

white, ProShield

2002 000 000

#### Version

Glossy, matt, special colour

#### Fittings information

Impact area approx. 110 – 170 mm from rear edge of basin.  
For parameters, see page 20.

#### Recommended miscellaneous

Bottle trap, Sl.2  
Bottle trap, Sl.3  
Drain valve, VT.1  
Angle valve cover, EV.3

#### Art. No.

8306 000 978  
8312 000 978  
8302 000 978  
8110 000 978

### EB . K450



Built-in basin, round, Ø 450 mm, height 159 mm, glazed steel, without tap hole, without overflow, included fixing set

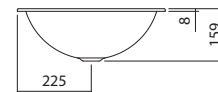
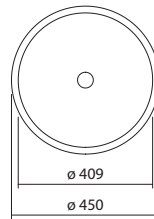

#### Art. No.

white, ProShield

2002 100 000

#### Version

Glossy, matt, special colour

#### Fittings information

Impact area approx. 110 – 170 mm from rear edge of basin.  
For parameters, see page 20.

#### Recommended miscellaneous

Bottle trap, Sl.2  
Bottle trap, Sl.3  
Drain valve, VT.3  
Angle valve cover, EV.3

#### Art. No.

8306 000 978  
8312 000 978  
8305 000 000  
8110 000 978

**Built-in basins – KE-series (Unisono)**Cut-out dimensions: Download [www.alape.com](http://www.alape.com)**EB . KE325**

Built-in basin for 30mm thick counter tops, round, Ø 325 mm, height 104 mm, extending 25 mm over counter top, glazed steel, without tap hole, without overflow, included fixing set, drain valve, valve cap, chrome-plated, Ø 63 mm

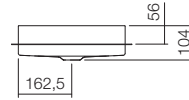
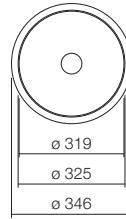
**Art. No.**

white, ProShield

2023 503 000

**Version**

Glossy, matt, special colour

**Fittings information**

Impact area approx. 95 – 130 mm from rear edge of basin.  
For parameters, see page 20.

**Recommended miscellaneous**

Bottle trap, Sl.2  
Bottle trap, Sl.3

**Art. No.**

8306 000 978  
8312 000 978

**EB . KE375**

Built-in basin for 30mm thick counter tops, round, Ø 375 mm, height 114 mm, extending 25 mm over counter top, glazed steel, without tap hole, without overflow, included fixing set, drain valve, valve cap, chrome-plated, Ø 74 mm

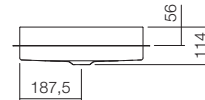
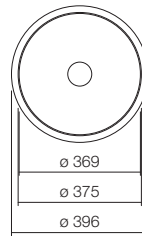
**Art. No.**

white, ProShield

2024 503 000

**Version**

Glossy, matt, special colour

**Fittings information**

Impact area approx. 110 – 155 mm from rear edge of basin.  
For parameters, see page 20.

**Recommended miscellaneous**

Bottle trap, Sl.2  
Bottle trap, Sl.3

**Art. No.**

8306 000 978  
8312 000 978

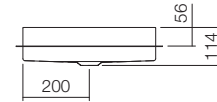
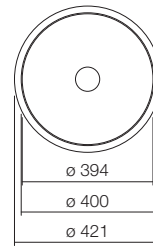

**Built-in basins – KE-series (Unisono)**Cut-out dimensions: Download [www.alape.com](http://www.alape.com)**EB . KE400**

Built-in basin for 30mm thick counter tops, round, Ø 400 mm, height 114 mm, extending 25 mm over counter top, glazed steel, without tap hole, without overflow, included fixing set, drain valve, valve cap, chrome-plated, Ø 74 mm



	<b>Art. No.</b>
white, ProShield	2025 503 000

<b>Version</b>	
Glossy, matt, special colour	

**Fittings information**

Impact area approx. 115 – 160 mm from rear edge of basin.  
For parameters, see page 20.

<b>Recommended miscellaneous</b>	<b>Art. No.</b>
Bottle trap, Sl.2	8306 000 978
Bottle trap, Sl.3	8312 000 978

**Built-in basins – O-series**Cut-out dimensions: Download [www.alape.com](http://www.alape.com)**EB . 0425**

Built-in basin, oval, w/h/d 425/110/325 mm, glazed steel, without tap hole, with overflow, included fixing set, overflow set

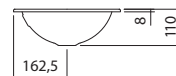
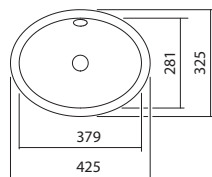
**Art. No.**

white, ProShield

2100 000 000

**Version**

Glossy, matt, special colour

**Fittings information**

Impact area approx. 100 – 125 mm from rear edge of basin.  
For parameters, see page 20.

**Recommended miscellaneous**

Bottle trap, Sl.2  
Bottle trap, Sl.3  
Drain valve, VT.1

**Art. No.**

8306 000 978  
8312 000 978  
8302 000 978

**EB . 0425**

Built-in basin, oval, w/h/d 425/110/325 mm, glazed steel, without tap hole, without overflow, included fixing set

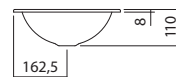
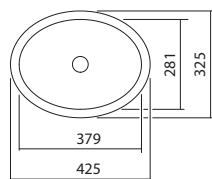
**Art. No.**

white, ProShield

2100 100 000

**Version**

Glossy, matt, special colour

**Fittings information**

Impact area approx. 100 – 125 mm from rear edge of basin.  
For parameters, see page 20.

**Recommended miscellaneous**

Bottle trap, Sl.2  
Bottle trap, Sl.3  
Drain valve, VT.2

**Art. No.**

8306 000 978  
8312 000 978  
8304 000 000

## Built-in basins – O-series

Cut-out dimensions: Download [www.alape.com](http://www.alape.com)

### EB . 0500H



Built-in basin, oval, w/h/d 500/110.5/400 mm, glazed steel, with one tap hole, with overflow, included fixing set, overflow set

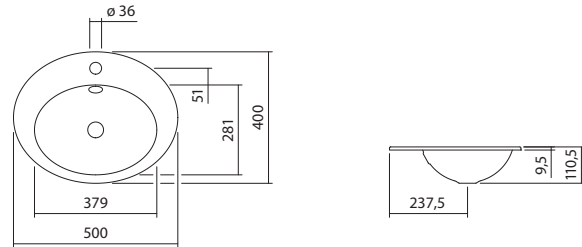

	Art. No.
white, ProShield	2102 000 000

**Version**  
 Without tap hole  
 3 Drill holes  
 Drill hole for lotion dispenser  
 Glossy, matt, special colour

#### Fittings information

Impact area approx. 120 – 140 mm from middle tap hole.  
 For parameters, see page 20.

Recommended miscellaneous	Art. No.
Bottle trap, Sl.2	8306 000 978
Bottle trap, Sl.3	8312 000 978
Drain valve, VT.1	8302 000 978
Angle valve cover, EV.3	8110 000 978

### EB . 0500H



Built-in basin, oval, w/h/d 500/110.5/400 mm, glazed steel, with one tap hole, without overflow, included fixing set

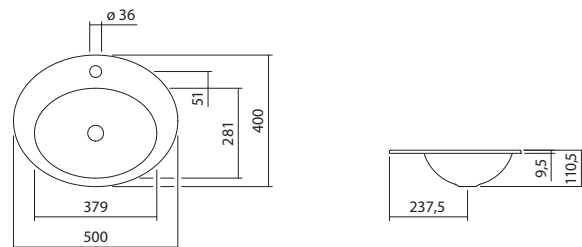

	Art. No.
white, ProShield	2102 100 000

**Version**  
 Without tap hole  
 3 Drill holes  
 Drill hole for lotion dispenser  
 Glossy, matt, special colour

#### Fittings information

Impact area approx. 120 – 140 mm from middle tap hole.  
 For parameters, see page 20.

Recommended miscellaneous	Art. No.
Bottle trap, Sl.2	8306 000 978
Bottle trap, Sl.3	8312 000 978
Drain valve, VT.2	8304 000 000
Angle valve cover, EV.3	8110 000 978

**Built-in basins – O-series**Cut-out dimensions: Download [www.alape.com](http://www.alape.com)**EB . 0525**

Built-in basin, oval, w/h/d 525/150/425 mm, glazed steel, without tap hole, with overflow, included fixing set, overflow set

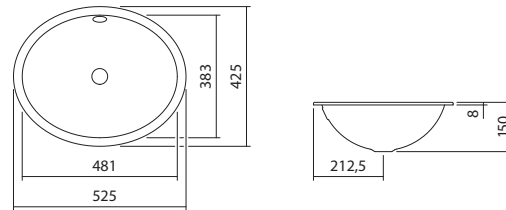

**Art. No.**  
white, ProShield 2101 000 000

**Version**  
Glossy, matt, special colour

**Fittings information**

Impact area approx. 120 – 165 mm from rear edge of basin.  
For parameters, see page 20.

**Recommended miscellaneous**

Bottle trap, Sl.2  
Bottle trap, Sl.3  
Drain valve, VT.1

**Art. No.**

8306 000 978  
8312 000 978  
8302 000 978

**EB . 0525**

Built-in basin, oval, w/h/d 525/150/425 mm, glazed steel, without tap hole, without overflow, included fixing set

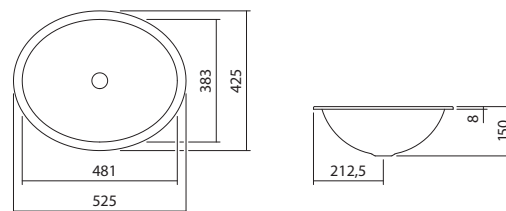

**Art. No.**  
white, ProShield 2101 100 000

**Version**  
Glossy, matt, special colour

**Fittings information**

Impact area approx. 120 – 165 mm from rear edge of basin.  
For parameters, see page 20.

**Recommended miscellaneous**

Bottle trap, Sl.2  
Bottle trap, Sl.3  
Drain valve, VT.3

**Art. No.**

8306 000 978  
8312 000 978  
8305 000 000

## Built-in basins – O-series

Cut-out dimensions: Download [www.alape.com](http://www.alape.com)

### EB . 0600H



Built-in basin, oval, w/h/d 600/150/500 mm, glazed steel, with one tap hole, with overflow, included fixing set, overflow set

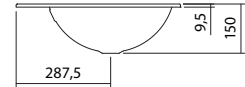
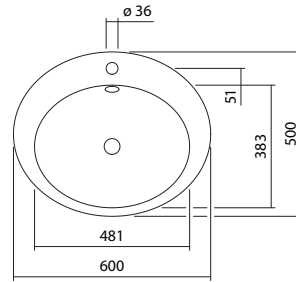

	Art. No.
white, ProShield	2104 000 000

**Version**  
 Without tap hole  
 3 Drill holes  
 Drill hole for lotion dispenser  
 Glossy, matt, special colour

#### Fittings information

Impact area approx. 160 – 180 mm from middle tap hole.  
 For parameters, see page 20.

Recommended miscellaneous	Art. No.
Bottle trap, Sl.2	8306 000 978
Bottle trap, Sl.3	8312 000 978
Drain valve, VT.1	8302 000 978
Angle valve cover, EV.3	8110 000 978

### EB . 0600H



Built-in basin, oval, w/h/d 600/150/500 mm, glazed steel, with one tap hole, without overflow, included fixing set

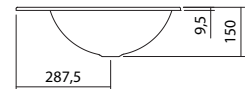
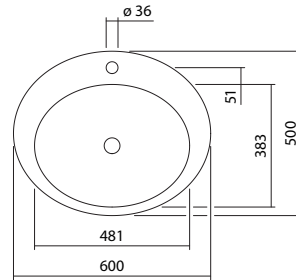

	Art. No.
white, ProShield	2104 100 000

**Version**  
 Without tap hole  
 3 Drill holes  
 Drill hole for lotion dispenser  
 Glossy, matt, special colour

#### Fittings information

Impact area approx. 160 – 180 mm from middle tap hole.  
 For parameters, see page 20.

Recommended miscellaneous	Art. No.
Bottle trap, Sl.2	8306 000 978
Bottle trap, Sl.3	8312 000 978
Drain valve, VT.3	8305 000 000
Angle valve cover, EV.3	8110 000 978

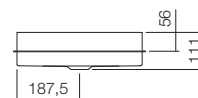
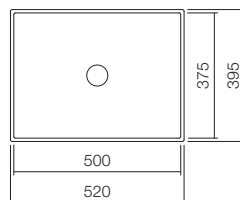
**Built-in basins – ME-series (Metaphor)**Cut-out dimensions: Download [www.alape.com](http://www.alape.com)**EB . ME500**

Built-in basin for 30mm thick counter tops, rectangular, w/h/d 500/111/375 mm, extending 25 mm over counter top, glazed steel, without tap hole, without overflow, included fixing set, drain valve, valve cap, chrome-plated, Ø 63 mm

**Art. No.**

white, ProShield

2226 503 000

**Version**

Glossy, matt, special colour

**Fittings information**

Impact area approx. 100 – 145 mm from rear edge of basin.  
For parameters, see page 20.

**Recommended miscellaneous**

Bottle trap, Sl.2  
Bottle trap, Sl.3

**Art. No.**

8306 000 978  
8312 000 978

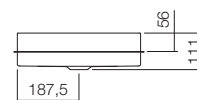
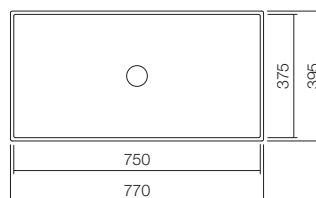
**EB . ME750**

Built-in basin for 30mm thick counter tops, rectangular, w/h/d 750/111/375 mm, extending 25 mm over counter top, glazed steel, without tap hole, without overflow, included fixing set, drain valve, valve cap, chrome-plated, Ø 63 mm

**Art. No.**

white, ProShield

2227 503 000

**Version**

Glossy, matt, special colour

**Fittings information**

Impact area approx. 100 – 145 mm from rear edge of basin.  
For parameters, see page 20.

**Recommended miscellaneous**

Bottle trap, Sl.2  
Bottle trap, Sl.3

**Art. No.**

8306 000 978  
8312 000 978

**Built-in basins – SR-series (Stream)**Cut-out dimensions: Download [www.alape.com](http://www.alape.com)**EB . SR650H**

Built-in basin, rectangular, w/h/d 650/127/472 mm, glazed steel, with one tap hole, with overflow, included fixing set, overflow set

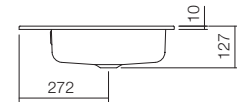
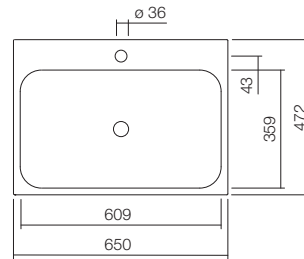

	<b>Art. No.</b>
white, ProShield	2219 600 000

**Fittings information**

Impact area approx. 105 – 155 mm from middle tap hole.  
For parameters, see page 20.

**Version**

Without tap hole  
3 Drill holes  
Drill hole for lotion dispenser  
Glossy, matt, special colour

**Recommended miscellaneous**

Bottle trap, Sl.2  
Bottle trap, Sl.3  
Drain valve, VT.1  
Angle valve cover, EV.3

**Art. No.**

8306 000 978  
8312 000 978  
8302 000 978  
8110 000 978

**EB . SR650H**

Built-in basin, rectangular, w/h/d 650/127/472 mm, glazed steel, with one tap hole, without overflow, included fixing set

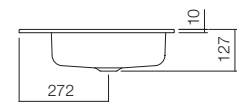
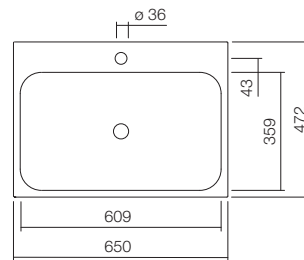

	<b>Art. No.</b>
white, ProShield	2219 800 000

**Fittings information**

Impact area approx. 105 – 155 mm from middle tap hole.  
For parameters, see page 20.

**Version**

Without tap hole  
3 Drill holes  
Drill hole for lotion dispenser  
Glossy, matt, special colour

**Recommended miscellaneous**

Bottle trap, Sl.2  
Bottle trap, Sl.3  
Drain valve, VT.3  
Angle valve cover, EV.3

**Art. No.**

8306 000 978  
8312 000 978  
8305 000 000  
8110 000 978

**Built-in basins – SR-series (Stream)**Cut-out dimensions: Download [www.alape.com](http://www.alape.com)**EB . SR650**

Built-in basin, rectangular, w/h/d 650/127/415 mm, glazed steel, without tap hole, with overflow, included fixing set, overflow set

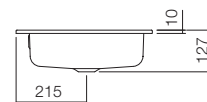
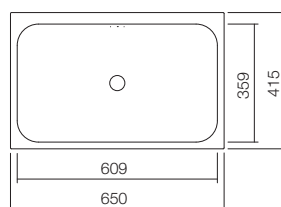

**Art. No.**  
white, ProShield 2218 700 000

**Version**  
Glossy, matt, special colour

**Fittings information**

Impact area approx. 98 – 148 mm from rear edge of basin.  
For parameters, see page 20.

**Recommended miscellaneous**

Bottle trap, Sl.2  
Bottle trap, Sl.3  
Drain valve, VT.1

**Art. No.**

8306 000 978  
8312 000 978  
8302 000 978

**EB . SR650**

Built-in basin, rectangular, w/h/d 650/127/415 mm, glazed steel, without tap hole, without overflow, included fixing set

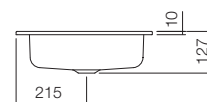
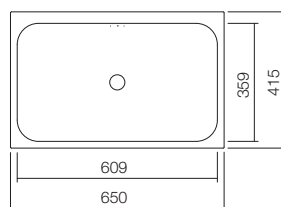

**Art. No.**  
white, ProShield 2218 500 000

**Version**  
Glossy, matt, special colour

**Fittings information**

Impact area approx. 98 – 148 mm from rear edge of basin.  
For parameters, see page 20.

**Recommended miscellaneous**

Bottle trap, Sl.2  
Bottle trap, Sl.3  
Drain valve, VT.3

**Art. No.**

8306 000 978  
8312 000 978  
8305 000 000



## Built-in basins – R-series

Cut-out dimensions: Download [www.alape.com](http://www.alape.com)

### EB . R585H



Built-in basin, rectangular, w/h/d 585/143/405 mm, glazed steel, with one tap hole, with overflow, included fixing set, overflow set

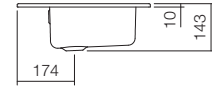
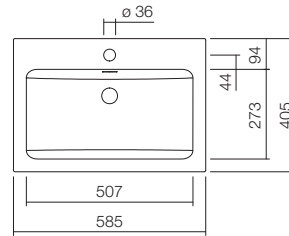

#### Art. No.

white, ProShield

2202 000 000

#### Version

Without tap hole  
3 Drill holes  
Drill hole for lotion dispenser  
Glossy, matt, special colour

#### Fittings information

Impact area approx. 170 – 190 mm from middle tap hole.  
For parameters, see page 20.

#### Recommended miscellaneous

Bottle trap, Sl.2  
Bottle trap, Sl.3  
Drain valve, VT.1  
Angle valve cover, EV.3

#### Art. No.

8306 000 978  
8312 000 978  
8302 000 978  
8110 000 978

### EB . R585H



Built-in basin, rectangular, w/h/d 585/143/405 mm, glazed steel, with one tap hole, without overflow, included fixing set

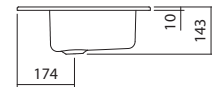
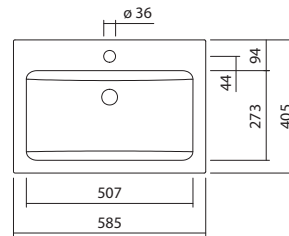

#### Art. No.

white, ProShield

2202 100 000

#### Version

Without tap hole  
3 Drill holes  
Drill hole for lotion dispenser  
Glossy, matt, special colour

#### Fittings information

Impact area approx. 170 – 190 mm from middle tap hole.  
For parameters, see page 20.

#### Recommended miscellaneous

Bottle trap, Sl.2  
Bottle trap, Sl.3  
Drain valve, VT.3  
Angle valve cover, EV.3

#### Art. No.

8306 000 978  
8312 000 978  
8305 000 000  
8110 000 978

**Built-in basins – R-series**Cut-out dimensions: Download [www.alape.com](http://www.alape.com)**EB . R585**

Built-in basin, rectangular, w/h/d 585/143/347 mm, glazed steel, without tap hole, with overflow, included fixing set, overflow set

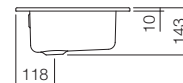
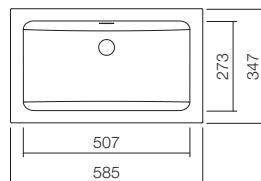

	<b>Art. No.</b>
white, ProShield	2201 000 000

<b>Version</b>	
Glossy, matt, special colour	

**Fittings information**

Impact area approx. 160 – 180 mm from rear edge of basin.  
For parameters, see page 20.

**Recommended miscellaneous**

Bottle trap, Sl.2  
Bottle trap, Sl.3  
Drain valve, VT.1

**Art. No.**

8306 000 978  
8312 000 978  
8302 000 978

**EB . R585**

Built-in basin, rectangular, w/h/d 585/143/347 mm, glazed steel, without tap hole, without overflow, included fixing set

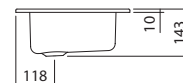
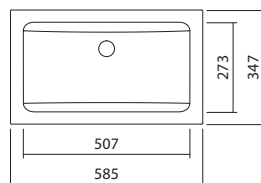

	<b>Art. No.</b>
white, ProShield	2201 100 000

<b>Version</b>	
Glossy, matt, special colour	

**Fittings information**

Impact area approx. 160 – 180 mm from rear edge of basin.  
For parameters, see page 20.

**Recommended miscellaneous**

Bottle trap, Sl.2  
Bottle trap, Sl.3  
Drain valve, VT.3

**Art. No.**

8306 000 978  
8312 000 978  
8305 000 000

## Built-in basins – R-series

Cut-out dimensions: Download [www.alape.com](http://www.alape.com)

### EB . R800H



Built-in basin, rectangular, w/h/d 800/120/500 mm, glazed steel, with one tap hole, with overflow, included fixing set, overflow set

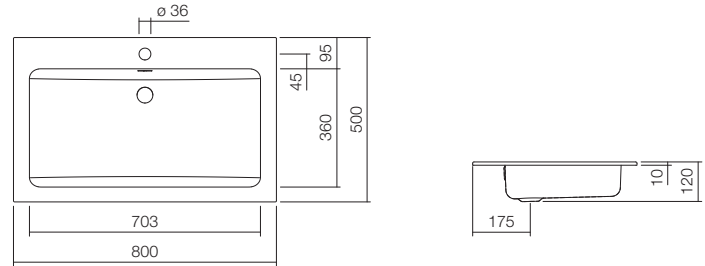

	Art. No.
white, ProShield	2204 200 000

Version
Without tap hole
3 Drill holes
Drill hole for lotion dispenser
Glossy, matt, special colour

#### Fittings information

Impact area approx. 185 – 240 mm from middle tap hole.  
For parameters, see page 20.

Recommended miscellaneous	Art. No.
Bottle trap, Sl.2	8306 000 978
Bottle trap, Sl.3	8312 000 978
Drain valve, VT.1	8302 000 978
Angle valve cover, EV.3	8110 000 978

### EB . R800H



Built-in basin, rectangular, w/h/d 800/120/500 mm, glazed steel, with one tap hole, without overflow, included fixing set

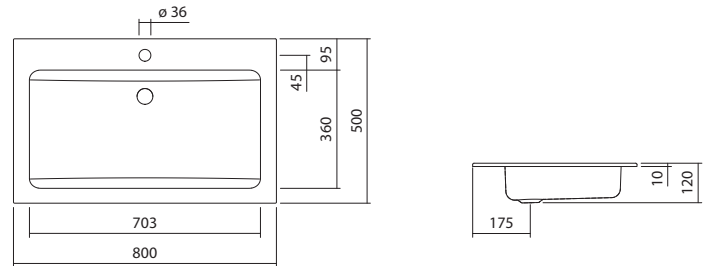

	Art. No.
white, ProShield	2204 000 000

Version
Without tap hole
3 Drill holes
Drill hole for lotion dispenser
Glossy, matt, special colour

#### Fittings information

Impact area approx. 185 – 240 mm from middle tap hole.  
For parameters, see page 20.

Recommended miscellaneous	Art. No.
Bottle trap, Sl.2	8306 000 978
Bottle trap, Sl.3	8312 000 978
Drain valve, VT.3	8305 000 000
Angle valve cover, EV.3	8110 000 978

**Built-in basins – R-series**Cut-out dimensions: Download [www.alape.com](http://www.alape.com)**EB . R800**

Built-in basin, rectangular, w/h/d 800/121/450 mm, glazed steel, without tap hole, with overflow, included fixing set, overflow set

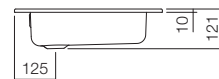
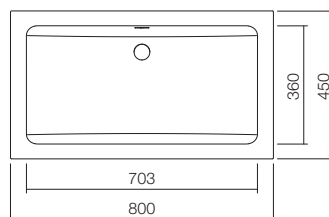
**Art. No.**

white, ProShield

2203 200 000

**Version**

Glossy, matt, special colour

**Fittings information**

Impact area approx. 185 – 240 mm from rear edge of basin.  
For parameters, see page 20.

**Recommended miscellaneous**

Bottle trap, SI.2  
Bottle trap, SI.3  
Drain valve, VT.1

**Art. No.**

8306 000 978  
8312 000 978  
8302 000 978

**EB . R800**

Built-in basin, rectangular, w/h/d 800/121/450 mm, glazed steel, without tap hole, without overflow, included fixing set

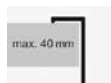
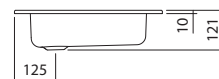
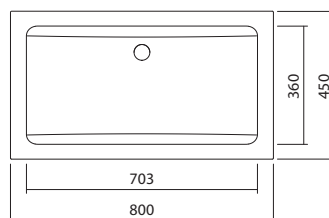
**Art. No.**

white, ProShield

2203 000 000

**Version**

Glossy, matt, special colour

**Fittings information**

Impact area approx. 185 – 240 mm from rear edge of basin.  
For parameters, see page 20.

**Recommended miscellaneous**

Bottle trap, SI.2  
Bottle trap, SI.3  
Drain valve, VT.3

**Art. No.**

8306 000 978  
8312 000 978  
8305 000 000

**Built-in basins – RE-series (X.plicit)**Cut-out dimensions: Download [www.alape.com](http://www.alape.com)**EB.RE700H.2**

Built-in basin, rectangular, w/h/d 700/90/460 mm, glazed steel, with one tap hole, without overflow, included fixing set, drain valve, valve cap, white glazed, w/d 68/68 mm

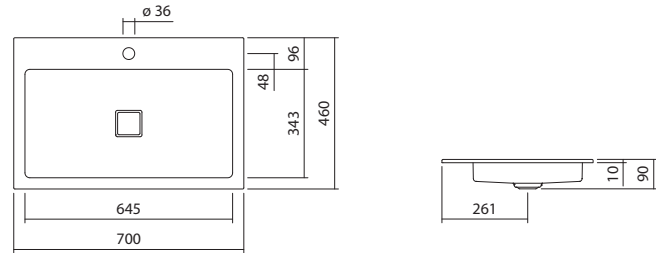

	Art. No.
white, ProShield	2208 000 000

**Fittings information**

Impact area approx. 120 – 150 mm from middle tap hole.  
For parameters, see page 20.

**Version**

Without tap hole  
3 Drill holes  
Drill hole for lotion dispenser  
Glossy, matt, special colour

**Recommended miscellaneous**

Bottle trap, Sl.2  
Bottle trap, Sl.3  
Angle valve cover, EV.3

**Art. No.**

8306 000 978  
8312 000 978  
8110 000 978

**EB.RE700.4**

Built-in basin, rectangular, w/h/d 700/90/398 mm, glazed steel, without tap hole, without overflow, included fixing set, drain valve, valve cap, white glazed, w/d 68/68 mm

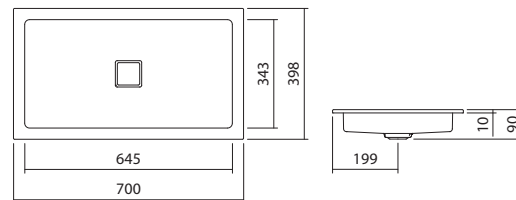

	Art. No.
white, ProShield	2207 000 000

**Fittings information**

Impact area approx. 105 – 140 mm from rear edge of basin.  
For parameters, see page 20.

**Version**

Glossy, matt, special colour

**Recommended miscellaneous**

Bottle trap, Sl.2  
Bottle trap, Sl.3

**Art. No.**

8306 000 978  
8312 000 978

**Built-in basins – Q-series**Cut-out dimensions: Download [www.alape.com](http://www.alape.com)**EB . Q450H**

Built-in basin, rectangular, w/h/d 450/94/500 mm, glazed steel, with one tap hole, without overflow, included fixing set, drain valve, valve cap, white glazed, w/d 68/68 mm

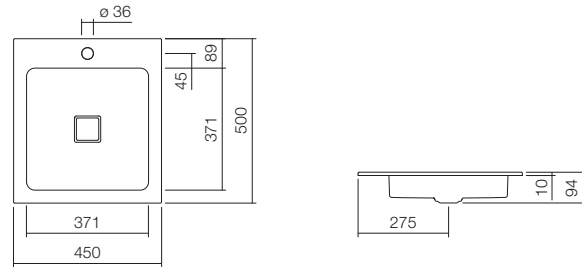
**Art. No.**

white, ProShield

2303 000 000

**Version**

3 Drill holes  
 Drill hole for lotion dispenser  
 Glossy, matt, special colour

**Fittings information**

Impact area approx. 120 – 175 mm from middle tap hole.  
 For parameters, see page 20.

**Recommended miscellaneous**

Bottle trap, Sl.2  
 Bottle trap, Sl.3  
 Angle valve cover, EV.3

**Art. No.**

8306 000 978  
 8312 000 978  
 8110 000 978

**EB . Q450**

Built-in basin, square, w/h/d 450/94/450 mm, glazed steel, without tap hole, without overflow, included fixing set, drain valve, valve cap, white glazed, w/d 68/68 mm

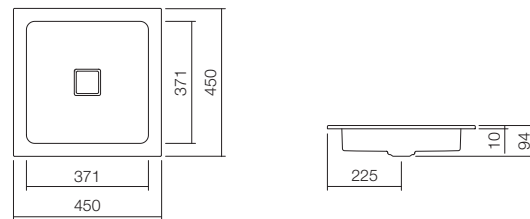
**Art. No.**

white, ProShield

2302 000 000

**Version**

Glossy, matt, special colour

**Fittings information**

Impact area approx. 115 – 170 mm from rear edge of basin.  
 For parameters, see page 20.

**Recommended miscellaneous**

Bottle trap, Sl.2  
 Bottle trap, Sl.3

**Art. No.**

8306 000 978  
 8312 000 978

## Semi recessed basins – S-series, R-series

Cut-out dimensions: Download [www.alape.com](http://www.alape.com)

## HB . S450H



Semi-recessed basin, round, Ø 450 mm, height 163 mm, glazed steel, with one tap hole, with overflow, included fixing set, overflow set

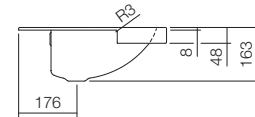
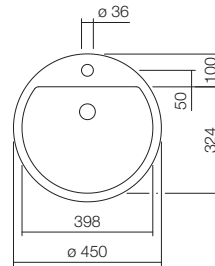

	Art. No.
white, ProShield	2900 000 000

## Fittings information

Impact area approx. 170 – 210 mm from middle tap hole.  
For parameters, see page 20.

Version	Art. No.
Without tap hole	
Without overflow	
3 Drill holes	
Drill hole for lotion dispenser	
Glossy, matt, special colour	

Recommended miscellaneous	Art. No.
Bottle trap, Sl.2	8306 000 978
Bottle trap, Sl.3	8312 000 978
Drain valve, VT.1	8302 000 978
Angle valve cover, EV.3	8110 000 978

## HB . R585H



Semi-recessed basin, rectangular, w/h/d 585/143/405 mm, glazed steel, with one tap hole, with overflow, included fixing set, overflow set

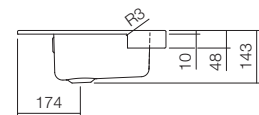
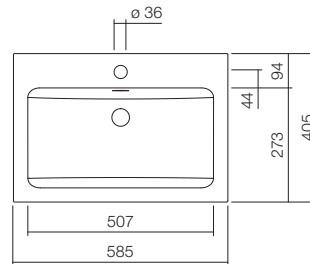

	Art. No.
white, ProShield	2700 000 000

## Fittings information

Impact area approx. 170 – 190 mm from middle tap hole.  
For parameters, see page 20.

Version	Art. No.
Without tap hole	
Without overflow	
3 Drill holes	
Drill hole for lotion dispenser	
Glossy, matt, special colour	

Recommended miscellaneous	Art. No.
Bottle trap, Sl.2	8306 000 978
Bottle trap, Sl.3	8312 000 978
Drain valve, VT.1	8302 000 978
Angle valve cover, EV.3	8110 000 978























# Sit-on basins

## **AB**



Unisono  
Sit-on basin  
**AB . KE400**  
ø 400 mm x 116mm



Basin width				
325 – 375 mm	400 – 700 mm	750 – 1000 mm		
 <p><b>AB.K325.2</b> ø 325 mm, height 125 mm Page 66</p>	 <p><b>AB.KE400</b> ø 400 mm, height 116 mm Page 69</p>	 <p><b>AB.K450.2</b> ø 450 mm, height 170 mm Page 68</p>	<b>Round</b>	
 <p><b>AB.KE325</b> ø 325 mm, height 105 mm Page 68</p>	 <p><b>AB.K400.2</b> ø 400 mm, height 155 mm Page 67</p>	 <p><b>AB.K450H.2</b> ø 450 mm, height 170 mm Page 67</p>		
 <p><b>AB.KE375</b> ø 375 mm, height 116 mm Page 69</p>	 <p><b>AB.K400H.2</b> ø 400 mm, height 155 mm Page 66</p>	 <p><b>AB.S0450.1</b> ø 450 mm, height 119 mm Page 70</p>		
	 <p><b>AB.S0400.1</b> ø 400 mm, height 102 mm Page 70</p>			
	 <p><b>AB.ME500</b> 500 x 375 mm, height 115 mm Page 71</p>	 <p><b>AB.SR650</b> 650 x 415 mm, height 50 mm Page 73</p>	 <p><b>AB.ME750</b> 750 x 375 mm, height 115 mm Page 71</p>	<b>Square and rectangular</b>
	 <p><b>AB.R585.1</b> 585 x 346 mm, height 60 mm Page 74</p>	 <p><b>AB.SR650H</b> 650 x 472 mm, height 50 mm Page 73</p>	 <p><b>AB.R800</b> 800 x 455 mm, height 75 mm Page 75</p>	
	 <p><b>AB.R585H.1</b> 585 x 405 mm, height 60 mm Page 74</p>	 <p><b>AB.RE700H.2</b> 700 x 460 mm, height 75 mm Page 76</p>	 <p><b>AB.R800H</b> 800 x 500 mm, height 75 mm Page 75</p>	
	 <p><b>AB.Q450.1</b> 450 x 450 mm, height 110 mm Page 77</p>	 <p><b>AB.RE700.4</b> 700 x 398 mm, height 75 mm Page 76</p>	 <p><b>AB.ME1000</b> 1000 x 375 mm, height 115 mm Page 72</p>	
	 <p><b>AB.Q450H.1</b> 450 x 500 mm, height 110 mm Page 77</p>			

**Sit-on basins – K-series**Cut-out dimensions: Download [www.alape.com](http://www.alape.com)**AB . K325 . 2**

Sit-on basin, round, Ø 325 mm, height 125 mm, glazed steel, without tap hole, with overflow, included fixing set, overflow set

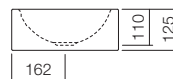
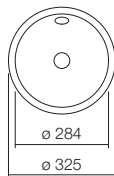
**Art. No.**

white, ProShield

3000 200 000

**Version**

Without overflow  
Glossy, matt, special colour

**Fittings information**

Impact area approx. 85 – 115 mm from rear edge of basin.  
For parameters, see page 20.

**Recommended miscellaneous**

Bottle trap, Sl.2  
Bottle trap, Sl.3  
Drain valve, VT.1

**Art. No.**

8306 000 978  
8312 000 978  
8302 000 978

**AB . K400H . 2**

Sit-on basin, round, Ø 400 mm, height 155 mm, glazed steel, with one tap hole, with overflow, included fixing set, overflow set

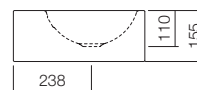
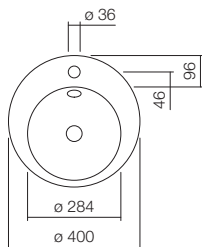
**Art. No.**

white, ProShield

3004 200 000

**Version**

Without overflow  
3 Drill holes  
Drill hole for lotion dispenser  
Glossy, matt, special colour

**Fittings information**

Impact area approx. 110 – 140 mm from middle tap hole.  
For parameters, see page 20.

**Recommended miscellaneous**

Bottle trap, Sl.2  
Bottle trap, Sl.3  
Drain valve, VT.1  
Angle valve cover, EV.3

**Art. No.**

8306 000 978  
8312 000 978  
8302 000 978  
8110 000 978

## Sit-on basins – K-series

Cut-out dimensions: Download [www.alape.com](http://www.alape.com)

### AB . K400 . 2



Sit-on basin, round, Ø 400 mm, height 155 mm, glazed steel, without tap hole, with overflow, included fixing set, overflow set

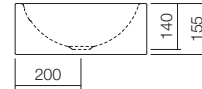
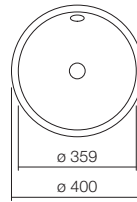

#### Art. No.

white, ProShield

3002 200 000

#### Version

Without overflow  
Glossy, matt, special colour

#### Fittings information

Impact area approx. 110 – 150 mm from rear edge of basin.  
For parameters, see page 20.

#### Recommended miscellaneous

Bottle trap, Sl.2  
Bottle trap, Sl.3  
Drain valve, VT.1

#### Art. No.

8306 000 978  
8312 000 978  
8302 000 978

### AB . K450H . 2



Sit-on basin, round, Ø 450 mm, height 170 mm, glazed steel, with one tap hole, with overflow, included fixing set, overflow set

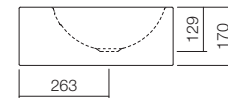
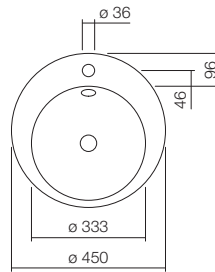

#### Art. No.

white, ProShield

3008 000 000

#### Version

Without overflow  
3 Drill holes  
Drill hole for lotion dispenser  
Glossy, matt, special colour

#### Fittings information

Impact area approx. 140 – 160 mm from middle tap hole.  
For parameters, see page 20.

#### Recommended miscellaneous

Bottle trap, Sl.2  
Bottle trap, Sl.3  
Drain valve, VT.1  
Angle valve cover, EV.3

#### Art. No.

8306 000 978  
8312 000 978  
8302 000 978  
8110 000 978

**Sit-on basins – K-series, KE-series**Cut-out dimensions: Download [www.alape.com](http://www.alape.com)**AB . K450 . 2**

Sit-on basin, round, Ø 450 mm, height 170 mm, glazed steel, without tap hole, with overflow, included fixing set, overflow set

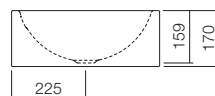
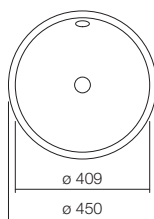

	<b>Art. No.</b>
white, ProShield	3006 200 000

<b>Version</b>	
Without overflow	
Glossy, matt, special colour	

**Fittings information**

Impact area approx. 110 – 170 mm from rear edge of basin.  
For parameters, see page 20.

<b>Recommended miscellaneous</b>	<b>Art. No.</b>
Bottle trap, Sl.2	8306 000 978
Bottle trap, Sl.3	8312 000 978
Drain valve, VT.1	8302 000 978

**AB . KE325**

Sit-on basin, round, Ø 325 mm, height 106 mm, glazed steel, without tap hole, without overflow, included fixing set, drain valve, valve cap, chrome-plated, Ø 63 mm, black spacer ring

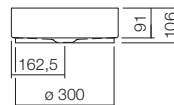
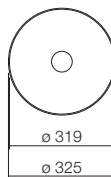

	<b>Art. No.</b>
white, ProShield	3220 000 000

<b>Version</b>	
Glossy, matt, special colour	

**Fittings information**

Impact area approx. 85 – 120 mm from rear edge of basin.  
For parameters, see page 20.

<b>Recommended miscellaneous</b>	<b>Art. No.</b>
Bottle trap, Sl.2	8306 000 978
Bottle trap, Sl.3	8312 000 978

**Sit-on basins – KE-series (Unisono)**Cut-out dimensions: Download [www.alape.com](http://www.alape.com)**AB . KE375**

Sit-on basin, round, Ø 375 mm, height 116 mm, glazed steel, without tap hole, without overflow, included fixing set, drain valve, valve cap, chrome-plated, Ø 74 mm, black spacer ring

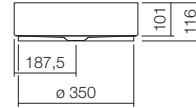
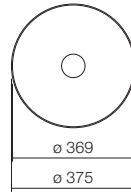

	<b>Art. No.</b>
white, ProShield	3221 000 000

<b>Version</b>	
Glossy, matt, special colour	

**Fittings information**

Impact area approx. 100 – 145 mm from rear edge of basin.  
For parameters, see page 20.

<b>Recommended miscellaneous</b>	<b>Art. No.</b>
Bottle trap, Sl.2	8306 000 978
Bottle trap, Sl.3	8312 000 978

**AB . KE400**

Sit-on basin, round, Ø 400 mm, height 116 mm, glazed steel, without tap hole, without overflow, included fixing set, drain valve, valve cap, chrome-plated, Ø 74 mm, black spacer ring

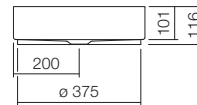
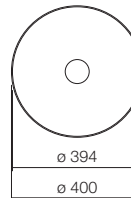

	<b>Art. No.</b>
white, ProShield	3222 000 000
bicolor > see chapter: Special glazes	
matt black > see chapter: Special glazes	

<b>Version</b>	
Glossy, matt, special colour	

**Fittings information**

Impact area approx. 105 – 150 mm from rear edge of basin.  
For parameters, see page 20.

<b>Recommended miscellaneous</b>	<b>Art. No.</b>
Bottle trap, Sl.2	8306 000 978
Bottle trap, Sl.3	8312 000 978

**Sit-on basins – SO-series**Cut-out dimensions: Download [www.alape.com](http://www.alape.com)**AB . S0400 . 1**

Sit-on basin, round, Ø 400 mm, height 102 mm, glazed steel, without tap hole, without overflow, included fixing set, drain valve, valve cap, chrome-plated, Ø 74 mm, white spacer ring

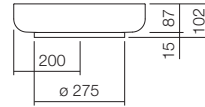
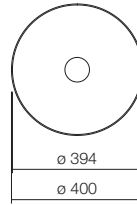
**Art. No.**

white, ProShield  
bicolor > see chapter: Special glazes  
dark iron > see chapter: Special glazes  
matt black > see chapter: Special glazes

3509 000 000

**Version**

Glossy, matt, special colour

**Fittings information**

Impact area approx. 60 – 150 mm from rear edge of basin.  
For parameters, see page 20.

**Recommended miscellaneous**

Bottle trap, Sl.2  
Bottle trap, Sl.3

**Art. No.**

8306 000 978  
8312 000 978

**AB . S0450 . 1**

Sit-on basin, round, Ø 450 mm, height 119 mm, glazed steel, without tap hole, without overflow, included fixing set, drain valve, valve cap, chrome-plated, Ø 74 mm, white spacer ring

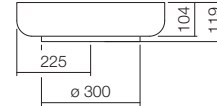
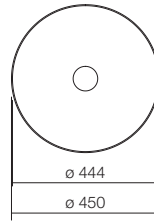
**Art. No.**

white, ProShield  
bicolor > see chapter: Special glazes  
dark iron > see chapter: Special glazes  
matt black > see chapter: Special glazes

3503 000 000

**Version**

Glossy, matt, special colour

**Fittings information**

Impact area approx. 60 – 170 mm from rear edge of basin.  
For parameters, see page 20.

**Recommended miscellaneous**

Bottle trap, Sl.2  
Bottle trap, Sl.3

**Art. No.**

8306 000 978  
8312 000 978

**Sit-on basins – ME-series (Metaphor)**Cut-out dimensions: Download [www.alape.com](http://www.alape.com)**AB . ME500**

Sit-on basin, rectangular, w/h/d 500/115/375 mm, glazed steel, without tap hole, without overflow, included fixing set, drain valve, valve cap, chrome-plated, Ø 63 mm, black spacer frame

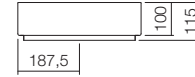
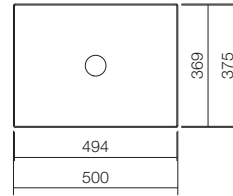

**Art. No.**  
white, ProShield 3212 000 000

**Version**  
Glossy, matt, special colour

**Fittings information**

Impact area approx. 90 – 135 mm from rear edge of basin.  
For parameters, see page 20.

**Recommended miscellaneous**

Bottle trap, Sl.2  
Bottle trap, Sl.3

**Art. No.**

8306 000 978  
8312 000 978

**AB . ME750**

Sit-on basin, rectangular, w/h/d 750/115/375 mm, glazed steel, without tap hole, without overflow, included fixing set, drain valve, valve cap, chrome-plated, Ø 63 mm, black spacer frame

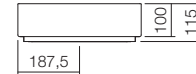
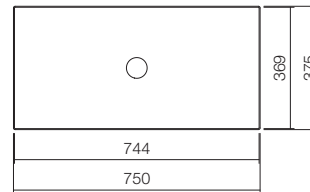

**Art. No.**  
white, ProShield 3213 000 000

**Version**  
Glossy, matt, special colour

**Fittings information**

Impact area approx. 90 – 135 mm from rear edge of basin.  
For parameters, see page 20.

**Recommended miscellaneous**

Bottle trap, Sl.2  
Bottle trap, Sl.3

**Art. No.**

8306 000 978  
8312 000 978

**Sit-on basins – ME-series (Metaphor)**Cut-out dimensions: Download [www.alape.com](http://www.alape.com)**AB . ME1000**

Sit-on basin, rectangular, w/h/d 1000/115/375 mm, glazed steel, without tap hole, without overflow, included fixing set, drain valve, valve cap, chrome-plated, Ø 63 mm, black spacer frame

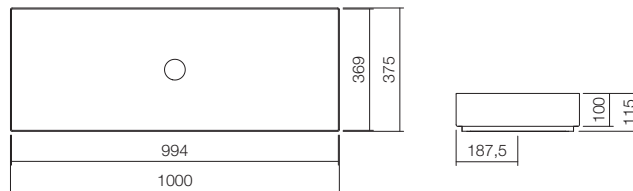
**Art. No.**

white, ProShield

3214 000 000

**Version**

Glossy, matt, special colour

**Fittings information**

Impact area approx. 90 – 135 mm from rear edge of basin.  
For parameters, see page 20.

**Recommended miscellaneous**

Bottle trap, Sl.2  
Bottle trap, Sl.3

**Art. No.**

8306 000 978  
8312 000 978



## Sit-on basins – SR-series (Stream)

Cut-out dimensions: Download [www.alape.com](http://www.alape.com)

### AB . SR650H



Sit-on basin, rectangular, w/h/d 650/127/472 mm, glazed steel, with one tap hole, with overflow, included fixing set, overflow set

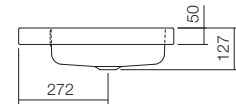
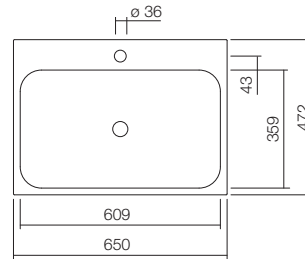

	Art. No.
white, ProShield	3231 600 000

#### Fittings information

Impact area approx. 105 – 155 mm from middle tap hole.  
For parameters, see page 20.

#### Version

Without overflow  
3 Drill holes  
Drill hole for lotion dispenser  
Glossy, matt, special colour

#### Recommended miscellaneous

Bottle trap, Sl.2  
Bottle trap, Sl.3  
Drain valve, VT.1  
Angle valve cover, EV.3

#### Art. No.

8306 000 978  
8312 000 978  
8302 000 978  
8110 000 978

### AB . SR650



Sit-on basin, rectangular, w/h/d 650/127/415 mm, glazed steel, without tap hole, with overflow, included fixing set, overflow set

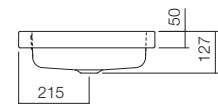
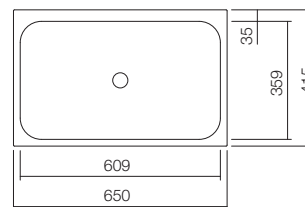

	Art. No.
white, ProShield	3230 700 000

#### Fittings information

Impact area approx. 98 – 148 mm from rear edge of basin.  
For parameters, see page 20.

#### Version

Without overflow  
Glossy, matt, special colour

#### Recommended miscellaneous

Bottle trap, Sl.2  
Bottle trap, Sl.3  
Drain valve, VT.1

#### Art. No.

8306 000 978  
8312 000 978  
8302 000 978

**Sit-on basins – R-series**Cut-out dimensions: Download [www.alape.com](http://www.alape.com)**AB . R585H . 1**

Sit-on basin, rectangular, w/h/d 585/143/405 mm, glazed steel, with one tap hole, with overflow, included fixing set, overflow set

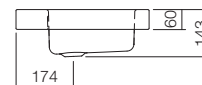
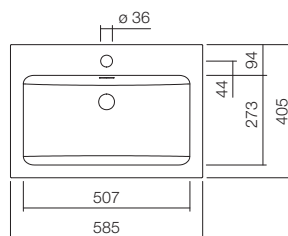

	<b>Art. No.</b>
white, ProShield	3202 000 000

<b>Version</b>
Without overflow
3 Drill holes
Drill hole for lotion dispenser
Glossy, matt, special colour

**Fittings information**

Impact area approx. 170 – 190 mm from middle tap hole.  
For parameters, see page 20.

<b>Recommended miscellaneous</b>	<b>Art. No.</b>
Bottle trap, Sl.2	8306 000 978
Bottle trap, Sl.3	8312 000 978
Drain valve, VT.1	8302 000 978
Angle valve cover, EV.3	8110 000 978

**AB . R585 . 1**

Sit-on basin, rectangular, w/h/d 585/143/346 mm, glazed steel, without tap hole, with overflow, included fixing set, overflow set

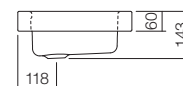
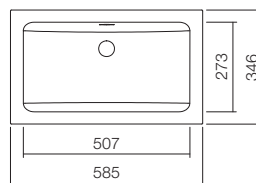

	<b>Art. No.</b>
white, ProShield	3205 000 000

<b>Version</b>
Without overflow
Glossy, matt, special colour

**Fittings information**

Impact area approx. 160 – 180 mm from rear edge of basin.  
For parameters, see page 20.

<b>Recommended miscellaneous</b>	<b>Art. No.</b>
Bottle trap, Sl.2	8306 000 978
Bottle trap, Sl.3	8312 000 978
Drain valve, VT.1	8302 000 978

## Sit-on basins – R-series

Cut-out dimensions: Download [www.alape.com](http://www.alape.com)

### AB . R800H



Sit-on basin, rectangular, w/h/d 800/120/500 mm, glazed steel, with one tap hole, with overflow, included fixing set, overflow set

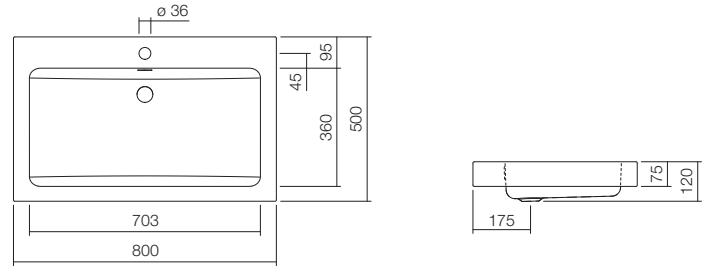

	Art. No.
white, ProShield	3206 200 000

#### Fittings information

Impact area approx. 185 – 240 mm from middle tap hole.  
For parameters, see page 20.

#### Version

Without overflow  
3 Drill holes  
Drill hole for lotion dispenser  
Glossy, matt, special colour

#### Recommended miscellaneous

Bottle trap, Sl.2  
Bottle trap, Sl.3  
Drain valve, VT.1  
Angle valve cover, EV.3

#### Art. No.

8306 000 978  
8312 000 978  
8302 000 978  
8110 000 978

### AB . R800



Sit-on basin, rectangular, w/h/d 800/120/455 mm, glazed steel, without tap hole, with overflow, included fixing set, overflow set

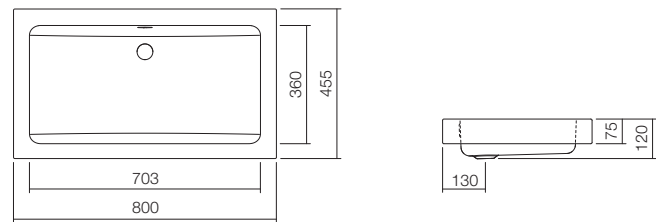

	Art. No.
white, ProShield	3207 200 000

#### Fittings information

Impact area approx. 190 – 245 mm from rear edge of basin.  
For parameters, see page 20.

#### Version

Without overflow  
Glossy, matt, special colour

#### Recommended miscellaneous

Bottle trap, Sl.2  
Bottle trap, Sl.3  
Drain valve, VT.1

#### Art. No.

8306 000 978  
8312 000 978  
8302 000 978

**Sit-on basins – RE-series (X.plicit)**

Cut-out dimensions: Download [www.alape.com](http://www.alape.com)

**AB . RE700H . 2**



Sit-on basin, rectangular, w/h/d 700/90/460 mm, glazed steel, with one tap hole, without overflow, included fixing set, drain valve, valve cap, white glazed, w/d 68/68 mm

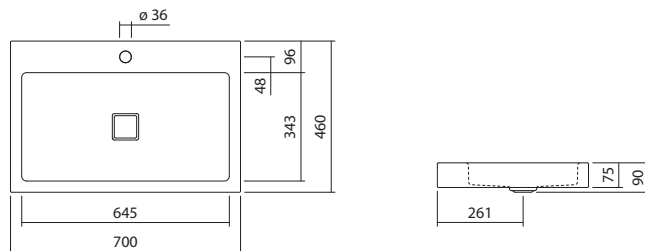

	<b>Art. No.</b>
white, ProShield	3209 000 000

<b>Version</b>
Without tap hole
3 Drill holes
Drill hole for lotion dispenser
Glossy, matt, special colour

<b>Fittings information</b>
Impact area approx. 120 – 150 mm from middle tap hole.
For parameters, see page 20.

<b>Recommended miscellaneous</b>	<b>Art. No.</b>
Bottle trap, Sl.2	8306 000 978
Bottle trap, Sl.3	8312 000 978
Angle valve cover, EV.3	8110 000 978

**AB . RE700 . 4**



Sit-on basin, rectangular, w/h/d 700/90/398 mm, glazed steel, without tap hole, without overflow, included fixing set, drain valve, valve cap, white glazed, w/d 68/68 mm

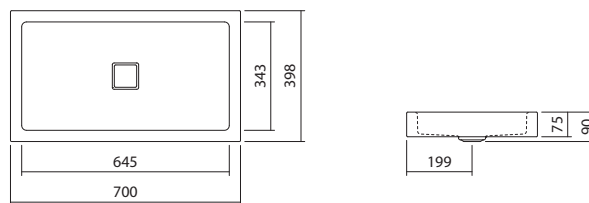

	<b>Art. No.</b>
white, ProShield	3208 000 000

<b>Version</b>
Glossy, matt, special colour

<b>Fittings information</b>
Impact area approx. 105 – 140 mm from rear edge of basin.
For parameters, see page 20.

<b>Recommended miscellaneous</b>	<b>Art. No.</b>
Bottle trap, Sl.2	8306 000 978
Bottle trap, Sl.3	8312 000 978

## Sit-on basins – Q-series

Cut-out dimensions: Download [www.alape.com](http://www.alape.com)

### AB . Q450H . 1



Sit-on basin, rectangular, w/h/d 450/110/500 mm, glazed steel, with one tap hole, without overflow, included fixing set, drain valve, valve cap, white glazed, w/d 68/68 mm

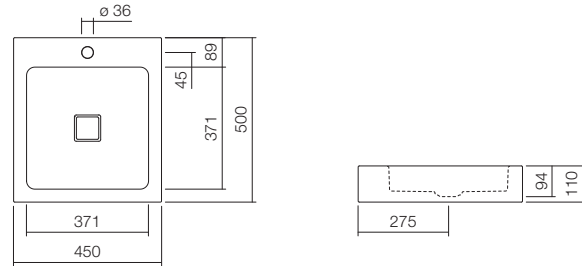

#### Art. No.

white, ProShield

3304 000 000

#### Version

3 Drill holes  
Drill hole for lotion dispenser  
Glossy, matt, special colour

#### Fittings information

Impact area approx. 120 – 175 mm from middle tap hole.  
For parameters, see page 20.

#### Recommended miscellaneous

Bottle trap, Sl.2  
Bottle trap, Sl.3  
Angle valve cover, EV.3

#### Art. No.

8306 000 978  
8312 000 978  
8110 000 978

### AB . Q450 . 1



Sit-on basin, square, w/h/d 450/110/450 mm, glazed steel, without tap hole, without overflow, included fixing set, drain valve, valve cap, white glazed, w/d 68/68 mm

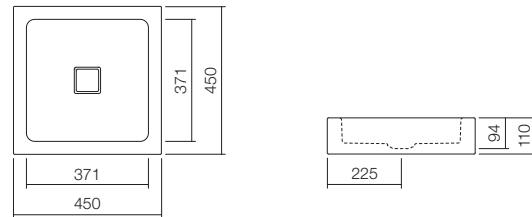

#### Art. No.

white, ProShield

3302 000 000

#### Version

Glossy, matt, special colour

#### Fittings information

Impact area approx. 115 – 170 mm from rear edge of basin.  
For parameters, see page 20.

#### Recommended miscellaneous

Bottle trap, Sl.2  
Bottle trap, Sl.3

#### Art. No.



8306 000 978  
8312 000 978

# Dish Basins

## **SB**



Scopio  
Dish basin  
**SB . C0375**  
ø 375 x 115mm

Basin width				
325 – 425mm	450 – 585mm	600 – 700mm	800 – 1000mm	
 <p><b>SB . K300 . GS</b> ø 300mm Page 80</p>	 <p><b>SB . K450 . GS</b> ø 450mm Page 81</p>			Round
 <p><b>SB . K360 . GS</b> ø 360mm Page 80</p>				
 <p><b>SB . C0375</b> ø 375mm Page 81</p>				
		 <p><b>SB . 0700 . GS</b> 703 x 403mm Page 82</p>		Oval
		 <p><b>SB . SR650</b> 599 x 349mm Page 82</p>		Square and rectangular

**Dish basins – GS-series**Cut-out dimensions: Download [www.alape.com](http://www.alape.com)**SB . K300 . GS**

Dish basin, round, Ø 300 mm, height 110 mm, glazed steel, without tap hole, without overflow, included drain valve, valve cap, chrome-plated, Ø 63 mm, chrome-plated spacer ring

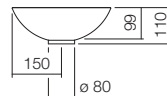
**Art. No.**

white, ProShield

3500 000 000

**Version**

Glossy, matt, special colour

**Fittings information**

Impact area approx. 80 – 110 mm from rear edge of basin.  
For parameters, see page 20.

**Recommended miscellaneous**

Bottle trap, Sl.2  
Bottle trap, Sl.3

**Art. No.**

8306 000 978  
8312 000 978

**SB . K360 . GS**

Dish basin, round, Ø 360 mm, height 130 mm, glazed steel, without tap hole, without overflow, included drain valve, valve cap, chrome-plated, Ø 63 mm, chrome-plated spacer ring

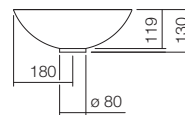
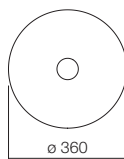
**Art. No.**

white, ProShield

3501 000 000

bicolor > see chapter: Special glazes  
dark iron > see chapter: Special glazes  
matt black > see chapter: Special glazes

**Version**

Glossy, matt, special colour

**Fittings information**

Impact area approx. 100 – 140 mm from rear edge of basin.  
For parameters, see page 20.

**Recommended miscellaneous**

Bottle trap, Sl.2  
Bottle trap, Sl.3

**Art. No.**

8306 000 978  
8312 000 978



## Dish basins – GS-series, CO-series

Cut-out dimensions: Download [www.alape.com](http://www.alape.com)

### SB . K450 . GS



Dish basin, round, Ø 450 mm, height 142 mm, glazed steel, without tap hole, without overflow, included drain valve, valve cap, chrome-plated, Ø 74 mm, chrome-plated spacer ring

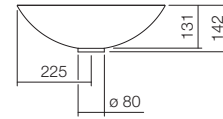
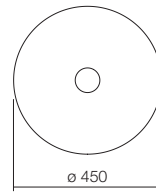

Art. No.
white, ProShield 3502 000 000

Version
Glossy, matt, special colour

#### Fittings information

Impact area approx. 130 – 180 mm from rear edge of basin.  
For parameters, see page 20.

#### Recommended miscellaneous

Bottle trap, Sl.2  
Bottle trap, Sl.3

#### Art. No.

8306 000 978  
8312 000 978

### SB . C0375



Dish basin, round, Ø 375 mm, height 115 mm, glazed steel, without tap hole, without overflow, included drain valve, valve cap, white glazed, Ø 74 mm, black spacer ring

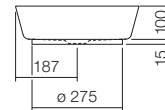
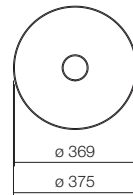

Art. No.
white, ProShield 3508 500 000

Version
Glossy, matt, special colour

#### Fittings information

Impact area approx. 100 – 135 mm from rear edge of basin.  
For parameters, see page 20.

#### Recommended miscellaneous

Bottle trap, Sl.2  
Bottle trap, Sl.3

#### Art. No.

8306 000 978  
8312 000 978

**Dish basins – GS-series, SR-series**Cut-out dimensions: Download [www.alape.com](http://www.alape.com)**SB . 0700 . GS**

Dish basin, oval, w/h/d 703/85/403 mm, glazed steel, without tap hole, without overflow, included drain valve, valve cap, white glazed, w/d 390/90 mm, white spacer frame

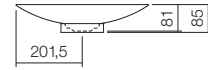
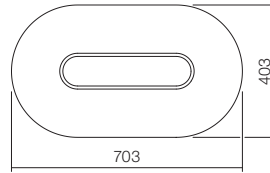
**Art. No.**

white, ProShield

3520 000 000

**Version**

Glossy, matt, special colour

**Fittings information**

Impact area approx. 120 – 150 mm from rear edge of basin.  
For parameters, see page 20.

**Recommended miscellaneous**

Bottle trap, Sl.2  
Bottle trap, Sl.3

**Art. No.**

8306 000 978  
8312 000 978

**SB . SR650**

Dish basin, rectangular, w/h/d 599/118/349 mm, glazed steel, without tap hole, without overflow, included drain valve, valve cap, chrome-plated, Ø 74 mm, chrome-plated spacer frame

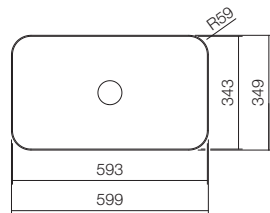
**Art. No.**

white, ProShield

3507 500 000

matt black > see chapter: Special glazes  
terra > see chapter: Special glazes

**Version**

Glossy, matt, special colour

**Fittings information**

Impact area approx. 58 – 108 mm from rear edge of basin.  
For parameters, see page 20.

**Recommended miscellaneous**

Bottle trap, Sl.2  
Bottle trap, Sl.3

**Art. No.**

8306 000 978  
8312 000 978

















Stream  
Dish basin  
**SB.SR650**  
599 x 118 x 349mm

# Special glazes



Aqua  
Dish basin

		Basin width		
		300 – 425 mm	450 – 600 mm	
Round	 <b>SB.Aqua300</b> ø 300 mm Seite 86	 <b>UB.K400</b> Mulde ø 359 mm Seite 96	 <b>SB.Aqua450</b> ø 450 mm Seite 87	Columns
	 <b>SB.Terra300</b> ø 300 mm Seite 88	 <b>AB.KE400</b> ø 400 mm Seite 90/93	 <b>SB.Terra450</b> ø 450 mm Seite 89	
	 <b>SB.Aqua360</b> ø 360 mm Seite 86	 <b>AB.S0400.1</b> ø 400 mm Seite 90/93/97	 <b>AB.S0450.1</b> ø 400 mm Seite 91/94/97	
	 <b>SB.Terra360</b> ø 360 mm Seite 88			
	 <b>SB.K360.GS</b> ø 360 mm Seite 91/94/98			
		 <b>WT.RX400.K</b> ø 400 mm Seite 98		
		 <b>WT.RX400.KE</b> ø 400 mm Seite 92		
		 <b>UB.0525</b> Mulde 472 x 373 mm Seite 96		Oval
		 <b>SB.SR650</b> 599 x 349 mm Seite 89/95		Rectangle

**SB . Aqua300**

Dish basin, round, Ø 300 mm, height 118 mm, glazed steel, without tap hole, without overflow, included drain valve, valve cap, glazed in the basin colour, Ø 84 mm

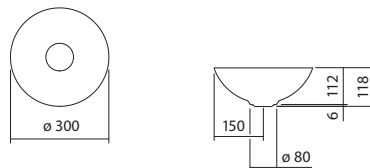

deep green



deep blue



deep indigo

	Art. No.
deep green	3900 000 091
deep blue	3900 000 092
deep indigo	3900 000 093

Recommended miscellaneous	Art. No.
Bottle trap, Sl.2	8306 000 978
Bottle trap, Sl.3	8312 000 978

**Fittings information**

Impact area approx. 80 – 110 mm from rear edge of basin.  
For parameters, see page 20.

**SB . Aqua360**

Dish basin, round, Ø 360 mm, height 137 mm, glazed steel, without tap hole, without overflow, included drain valve, valve cap, glazed in the basin colour, Ø 84 mm

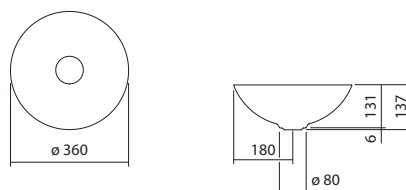

deep green



deep blue



deep indigo

	Art. No.
deep green	3901 000 091
deep blue	3901 000 092
deep indigo	3901 000 093

Recommended miscellaneous	Art. No.
Bottle trap, Sl.2	8306 000 978
Bottle trap, Sl.3	8312 000 978

**Fittings information**

Impact area approx. 100 – 140 mm from rear edge of basin.  
For parameters, see page 20.

**Aqua**Cut-out dimensions: Download [www.alape.com](http://www.alape.com)**SB . Aqua450**

Dish basin, round, Ø 450 mm, height 149 mm, glazed steel, without tap hole, without overflow, included drain valve, valve cap, glazed in the basin colour, Ø 92 mm

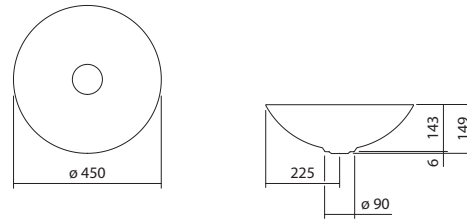

deep green



deep blue



deep indigo

	<b>Art. No.</b>
deep green	3902 000 091
deep blue	3902 000 092
deep indigo	3902 000 093

**Fittings information**

Impact area approx. 130 – 180 mm from rear edge of basin.  
For parameters, see page 20.

<b>Recommended miscellaneous</b>	<b>Art. No.</b>
Bottle trap, Sl.2	8306 000 978
Bottle trap, Sl.3	8312 000 978

**SB . Terra300**

Dish basin, round, Ø 300 mm, height 118 mm, glazed steel, without tap hole, without overflow, included drain valve, valve cap, glazed in the basin colour, Ø 84 mm

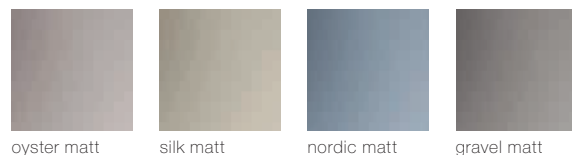
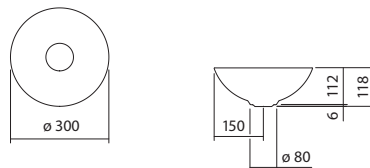

	Art. No.
oyster matt	3900 000 081
silk matt	3900 000 082
nordic matt	3900 000 083
gravel matt	3900 000 084

Recommended miscellaneous	Art. No.
Bottle trap, Sl.2	8306 000 978
Bottle trap, Sl.3	8312 000 978

**Fittings information**

Impact area approx. 80 – 110 mm from rear edge of basin.  
For parameters, see page 20.

**SB . Terra360**

Dish basin, round, Ø 360 mm, height 137 mm, glazed steel, without tap hole, without overflow, included drain valve, valve cap, glazed in the basin colour, Ø 84 mm

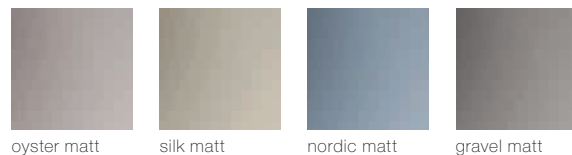
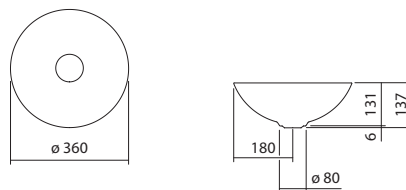

	Art. No.
oyster matt	3901 000 081
silk matt	3901 000 082
nordic matt	3901 000 083
gravel matt	3901 000 084

Recommended miscellaneous	Art. No.
Bottle trap, Sl.2	8306 000 978
Bottle trap, Sl.3	8312 000 978

**Fittings information**

Impact area approx. 100 – 140 mm from rear edge of basin.  
For parameters, see page 20.



## Terra

Cut-out dimensions: Download [www.alape.com](http://www.alape.com)

## SB . Terra450



Dish basin, round, Ø 450 mm, height 149 mm, glazed steel, without tap hole, without overflow, included drain valve, valve cap, glazed in the basin colour, Ø 92 mm

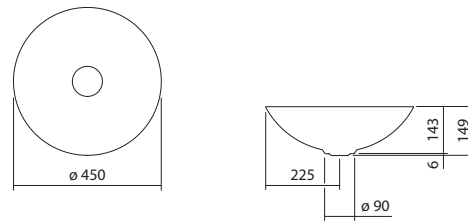

oyster matt



silk matt



nordic matt



gravel matt

	Art. No.
oyster matt	3902 000 081
silk matt	3902 000 082
nordic matt	3902 000 083
gravel matt	3902 000 084

## Fittings information

Impact area approx. 130 – 180 mm from rear edge of basin.  
For parameters, see page 20.

## Recommended miscellaneous

Bottle trap, Sl.2  
Bottle trap, Sl.3

## Art. No.

8306 000 978  
8312 000 978

## SB . SR650



Dish basin, rectangular, w/h/d 599/118/349 mm, glazed steel, without tap hole, without overflow, included drain valve, valve cap, glazed in the basin colour, Ø 84 mm, black spacer frame

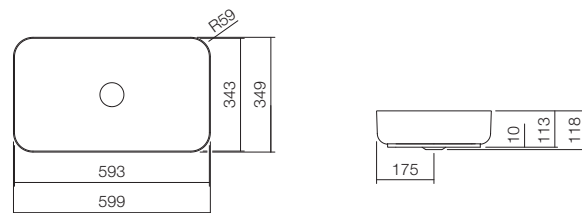

oyster matt



silk matt



nordic matt



gravel matt

	Art. No.
oyster matt	3521 500 081
silk matt	3521 500 082
nordic matt	3521 500 083
gravel matt	3521 500 084

## Fittings information

Impact area approx. 58 – 108 mm from rear edge of basin.  
For parameters, see page 20.

## Recommended miscellaneous

Bottle trap, Sl.2  
Bottle trap, Sl.3

## Art. No.

8306 000 978  
8312 000 978

**Bicolor**Cut-out dimensions: Download [www.alape.com](http://www.alape.com)**AB . KE400**

Sit-on basin, round, Ø 400 mm, height 116 mm, glazed steel, matt black/glossy white, without tap hole, without overflow, included fixing set, drain valve, valve cap, white glazed, Ø 74 mm, black spacer ring

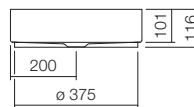
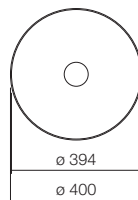

	<b>Art. No.</b>
matt black/glossy white	3222 000 180

<b>Recommended miscellaneous</b>	<b>Art. No.</b>
Bottle trap, Sl.2	8306 000 978
Bottle trap, Sl.3	8312 000 978

**Fittings information**

Impact area approx. 105 – 150 mm from rear edge of basin.  
For parameters, see page 20.

**AB . S0400 . 1**

Sit-on basin, round, Ø 400 mm, height 102 mm, glazed steel, matt black/glossy white, without tap hole, without overflow, included fixing set, drain valve, valve cap, white glazed, Ø 74 mm, black spacer ring

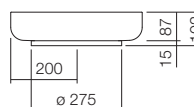
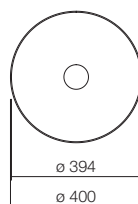

	<b>Art. No.</b>
matt black/glossy white	3509 000 180

<b>Recommended miscellaneous</b>	<b>Art. No.</b>
Bottle trap, Sl.2	8306 000 978
Bottle trap, Sl.3	8312 000 978

**Fittings information**

Impact area approx. 60 – 150 mm from rear edge of basin.  
For parameters, see page 20.

**Bicolor**Cut-out dimensions: Download [www.alape.com](http://www.alape.com)**AB.S0450.1**

Sit-on basin, round, Ø 450 mm, height 119 mm, glazed steel, matt black/glossy white, without tap hole, without overflow, included fixing set, drain valve, valve cap, white glazed, Ø 74 mm, black spacer ring

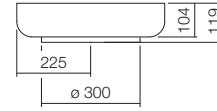
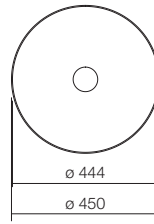

	<b>Art. No.</b>
matt black/glossy white	3503 000 180

<b>Recommended miscellaneous</b>	<b>Art. No.</b>
Bottle trap, Sl.2	8306 000 978
Bottle trap, Sl.3	8312 000 978

**Fittings information**

Impact area approx. 60 – 170 mm from rear edge of basin.  
For parameters, see page 20.

**SB.K360.GS**

Dish basin, round, Ø 360 mm, height 130 mm, glazed steel, matt black/glossy white, without tap hole, without overflow, included drain valve, valve cap, white glazed, Ø 63 mm, black spacer ring

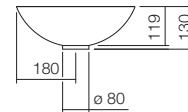
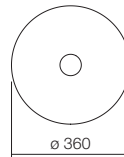

	<b>Art. No.</b>
matt black/glossy white	3501 000 180

<b>Recommended miscellaneous</b>	<b>Art. No.</b>
Bottle trap, Sl.2	8306 000 978
Bottle trap, Sl.3	8312 000 978

**Fittings information**

Impact area approx. 100 – 140 mm from rear edge of basin.  
For parameters, see page 20.

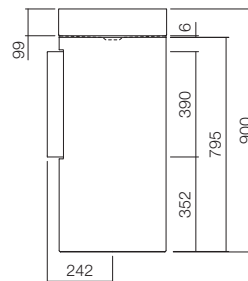
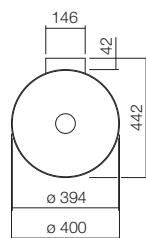
**Bicolor**Cut-out dimensions: Download [www.alape.com](http://www.alape.com)**WT . RX400 . KE**

Washstand, round, w/h/d 400/900/442 mm, sink round, centred, Ø 394 mm, sink depth 99 mm, glazed steel, matt black/glossy white, without tap hole, without overflow, included fixing set, drain valve, valve cap, white glazed, Ø 74 mm, bottle trap, chrome-plated spacer ring, black wall bracket

	<b>Art. No.</b>
matt black/glossy white	4506 500 180

<b>Recommended miscellaneous</b>	<b>Art. No.</b>
Mirror, SP.300	6719 000 899
Mirror, SP.325	6716 000 899

**Fittings information**

Impact area approx. 147 – 192 mm from rear edge of basin.  
For parameters, see page 20.

**Matt black**Cut-out dimensions: Download [www.alape.com](http://www.alape.com)**AB . KE400**

Sit-on basin, round, Ø 400 mm, height 116 mm, glazed steel, without tap hole, without overflow, included fixing set, drain valve, valve cap, glazed in the basin colour, Ø 74 mm, black spacer ring

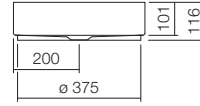
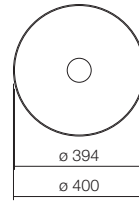

	<b>Art. No.</b>
matt black	3222 000 240

<b>Recommended miscellaneous</b>	<b>Art. No.</b>
Bottle trap, Sl.2	8306 000 978
Bottle trap, Sl.3	8312 000 978

**Fittings information**

Impact area approx. 105 – 150 mm from rear edge of basin.  
For parameters, see page 20.

**AB . S0400 . 1**

Sit-on basin, round, Ø 400 mm, height 102 mm, glazed steel, without tap hole, without overflow, included fixing set, drain valve, valve cap, glazed in the basin colour, Ø 74 mm, black spacer ring

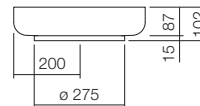
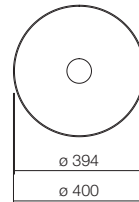

	<b>Art. No.</b>
matt black	3509 000 240

<b>Recommended miscellaneous</b>	<b>Art. No.</b>
Bottle trap, Sl.2	8306 000 978
Bottle trap, Sl.3	8312 000 978

**Fittings information**

Impact area approx. 60 – 150 mm from rear edge of basin.  
For parameters, see page 20.

**Matt black**Cut-out dimensions: Download [www.alape.com](http://www.alape.com)**AB.S0450.1**

Sit-on basin, round, Ø 450 mm, height 119 mm, glazed steel, without tap hole, without overflow, included fixing set, drain valve, valve cap, glazed in the basin colour, Ø 74 mm, black spacer ring

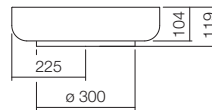
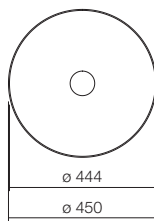

	<b>Art. No.</b>
matt black	3503 000 240

<b>Recommended miscellaneous</b>	<b>Art. No.</b>
Bottle trap, Sl.2	8306 000 978
Bottle trap, Sl.3	8312 000 978

**Fittings information**

Impact area approx. 60 – 170 mm from rear edge of basin.  
For parameters, see page 20.

**SB.K360.GS**

Dish basin, round, Ø 360 mm, height 130 mm, glazed steel, without tap hole, without overflow, included drain valve, valve cap, glazed in the basin colour, Ø 63 mm, black spacer ring

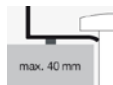
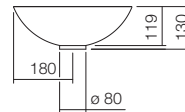
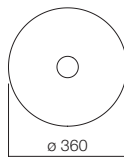

	<b>Art. No.</b>
matt black	3501 000 240

<b>Recommended miscellaneous</b>	<b>Art. No.</b>
Bottle trap, Sl.2	8306 000 978
Bottle trap, Sl.3	8312 000 978

**Fittings information**

Impact area approx. 100 – 140 mm from rear edge of basin.  
For parameters, see page 20.

**Matt black**Cut-out dimensions: Download [www.alape.com](http://www.alape.com)**SB . SR650**

Dish basin, rectangular, w/h/d 599/118/349 mm, glazed steel, without tap hole, without overflow, included drain valve, valve cap, glazed in the basin colour, Ø 84 mm, black spacer frame

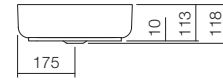
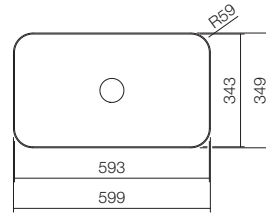

	<b>Art. No.</b>
matt black	3521 500 240

<b>Recommended miscellaneous</b>	<b>Art. No.</b>
Bottle trap, Sl.2	8306 000 978
Bottle trap, Sl.3	8312 000 978

**Fittings information**

Impact area approx. 58 – 108 mm from rear edge of basin.  
For parameters, see page 20.

**Metallic**Cut-out dimensions: Download [www.alape.com](http://www.alape.com)**UB . K400**

Undermount basin, round, Ø 359 mm, height 140 mm, glazed steel, metallic, without tap hole, without overflow, included fixing set, drain valve, valve cap, metallic dark iron glazed, Ø 74 mm

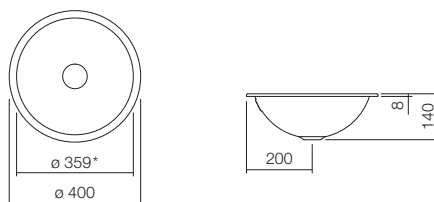

	<b>Art. No.</b>
dark iron	2031 500 190

<b>Recommended miscellaneous</b>	<b>Art. No.</b>
Bottle trap, Sl.2	8306 000 978
Bottle trap, Sl.3	8312 000 978

**Fittings information**

Impact area approx. 110 – 150 mm from rear edge of basin.  
For parameters, see page 20.

**UB . 0525**

Undermount basin, oval, w/h/d 481/150/383 mm, glazed steel, metallic, without tap hole, without overflow, included fixing set, drain valve, valve cap, metallic dark iron glazed, Ø 74 mm

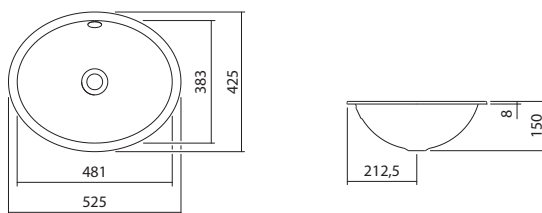

	<b>Art. No.</b>
dark iron	2111 500 190

<b>Recommended miscellaneous</b>	<b>Art. No.</b>
Bottle trap, Sl.2	8306 000 978
Bottle trap, Sl.3	8312 000 978

**Fittings information**

Impact area approx. 120 – 165 mm from rear edge of basin.  
For parameters, see page 20.



**Metallic**Cut-out dimensions: Download [www.alape.com](http://www.alape.com)**AB.S0400.1**

Sit-on basin, round, Ø 400 mm, height 102 mm, glazed steel, metallic, without tap hole, without overflow, included fixing set, drain valve, valve cap, glazed in the basin colour, Ø 74 mm, black spacer ring

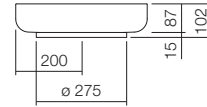
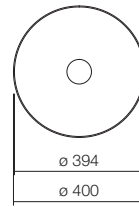

	<b>Art. No.</b>
dark iron	3509 000 190

<b>Recommended miscellaneous</b>	<b>Art. No.</b>
Bottle trap, Sl.2	8306 000 978
Bottle trap, Sl.3	8312 000 978

**Fittings information**

Impact area approx. 60 – 150 mm from rear edge of basin.  
For parameters, see page 20.

**AB.S0450.1**

Sit-on basin, round, Ø 450 mm, height 119 mm, glazed steel, metallic, without tap hole, without overflow, included fixing set, drain valve, valve cap, metallic dark iron glazed, Ø 74 mm, black spacer ring

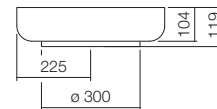
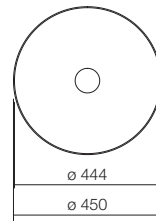

	<b>Art. No.</b>
dark iron	3503 000 190

<b>Recommended miscellaneous</b>	<b>Art. No.</b>
Bottle trap, Sl.2	8306 000 978
Bottle trap, Sl.3	8312 000 978

**Fittings information**

Impact area approx. 60 – 170 mm from rear edge of basin.  
For parameters, see page 20.

**Metallic**Cut-out dimensions: Download [www.alape.com](http://www.alape.com)**SB . K360 . GS**

Dish basin, round, Ø 360 mm, height 130 mm, glazed steel, metallic, without tap hole, without overflow, included drain valve, valve cap, metallic dark iron glazed, Ø 63 mm, black spacer ring

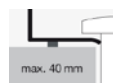
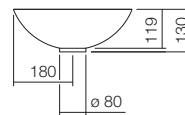
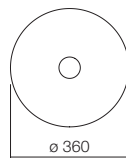

	<b>Art. No.</b>
dark iron	3501 000 190

<b>Recommended miscellaneous</b>	<b>Art. No.</b>
Bottle trap, Sl.2	8306 000 978
Bottle trap, Sl.3	8312 000 978

**Fittings information**

Impact area approx. 100 – 140 mm from rear edge of basin.  
For parameters, see page 20.

**WT . RX400K**

Washstand, round, w/h/d 404/900/444 mm, sink round, centred, Ø 359 mm, sink depth 140 mm, glazed steel, metallic, without tap hole, without overflow, included fixing set, drain valve, valve cap, metallic dark iron glazed, Ø 63 mm, bottle trap, black wall bracket

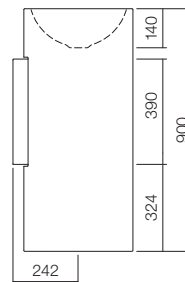
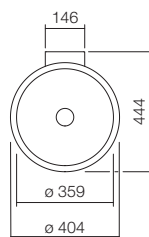

	<b>Art. No.</b>
dark iron	4503 000 190

<b>Recommended miscellaneous</b>	<b>Art. No.</b>
Mirror, SP.300	6719 000 899
Mirror, SP.325	6716 000 899

**Fittings information**

Impact area approx. 152 – 192 mm from rear edge of basin.  
For parameters, see page 20.



















































Washstand  
Metallic Dark Iron  
**WT.RX400K**  
404 x 900 x 444mm

# Washstands

## **WT**



Scopio  
Washstand  
**WT.RX400H.CO**  
400 x 900 x 500mm

Basin width				
325mm	400 – 600mm	650 – 800mm	1000 – 1250mm	
 <b>WT.RS325</b> ø 329mm I.P. 111	 <b>WT.CO400</b> ø 400mm I.P. 113  <b>WT.CO400H</b> ø 400mm I.P. 113  <b>WT.RS400</b> ø 400mm I.P. 111  <b>WT.RS450</b> ø 450mm I.P. 112			
 <b>WT.RX325.KE</b> ø 325 mm I.P. 107  <b>WT.RX325K</b> ø 329 mm I.P. 104/109  <b>WT.RX400.CU</b> ø 397 mm   P. 103  <b>WT.RX400H.CU</b> ø 397 mm   P. 103  <b>WT.RX400.CR</b> ø 397 mm   P. 102  <b>WT.RX400H.CR</b> ø 397 mm   P. 102	 <b>WT.RX400.KE</b> ø 400mm I.P. 107  <b>WT.RX400K</b> ø 404mm I.P. 105/109  <b>WT.RX400KH</b> ø 400mm I.P. 104  <b>WT.RX400H.CO</b> ø 400mm I.P. 106  <b>WT.RX400.CO</b> ø 400mm I.P. 106			
	Columns			
 <b>WT.IC325H</b> 325 x 325mm I.P. 114  <b>WT.QS325</b> 325 x 325mm I.P. 120  <b>WT.QS325H</b> 325 x 385mm I.P. 120  <b>WT.QS325X</b> 329 x 329mm I.P. 121	 <b>WT.QS450</b> 450 x 450mm I.P. 122  <b>WT.QS450H</b> 450 x 500mm I.P. 122  <b>WT.MC450H</b> 450 x 455mm I.P. 116  <b>WT.QS450HX</b> 450 x 500mm I.P. 121  <b>WT.XXS450.L/R</b> 450 x 236mm I.P. 118/119  <b>WT.XXS450H.L/R</b> 450 x 236mm I.P. 118/119  <b>WT.XS500.L/R</b> 500 x 268mm I.P. 125/126  <b>WT.XS500H.L/R</b> 500 x 268mm I.P. 125/126  <b>WT.QS525.L/R</b> 525 x 325mm I.P. 123/124  <b>WT.QS525H.L/R</b> 525 x 325mm I.P. 123/124  <b>WT.PR585</b> 585 x 347mm I.P. 128  <b>WT.PR585H</b> 585 x 405mm I.P. 128  <b>WT.IC600H</b> 600 x 325mm I.P. 114  <b>WT.IC600H.L/R</b> 600 x 325mm I.P. 115	 <b>WT.SR800H.L/R</b> 800 x 472mm I.P. 127  <b>WT.MC800H</b> 800 x 455mm I.P. 116  <b>WT.MC800H.L/R</b> 800 x 455mm I.P. 117  <b>WT.RE800H</b> 800 x 460mm I.P. 134  <b>WT.PR800</b> 800 x 405mm I.P. 129  <b>WT.PR800H</b> 800 x 405mm I.P. 129  <b>WT.PR800.L/R</b> 800 x 405mm I.P. 130/131  <b>WT.PR800H.L/R</b> 800 x 405mm I.P. 130/131  <b>WT.GR800H</b> 800 x 500mm I.P. 132	 <b>WT.RE1000H.L/R</b> 1000 x 460mm I.P. 134/135  <b>WT.GR1250H</b> 1250 x 500mm I.P. 132  <b>WT.GR1250H.L/R</b> 1250 x 500mm I.P. 133	
	Columns			
 <b>WT.RX325QS</b> 329 x 329mm P. 108/110	 <b>WT.RX450QS</b> 455 x 455mm I.P. 108/110			
	Columns			

Round

Square and rectangular

Undermount basins

Built-in basins

Sit-on basins

Dish basins

Special glazes

Washstands

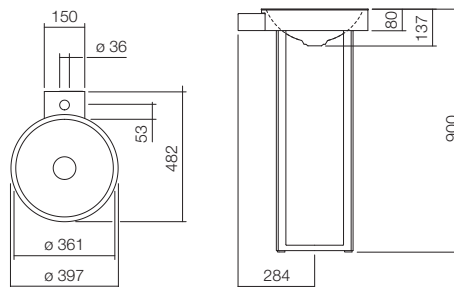
**WT . RX400H . CR**

Washstand, round, w/h/d 397/900/482 mm, sink round, centred, Ø 361 mm, sink depth 137 mm, glazed steel, with one tap hole, without overflow, steel bracket, powder finish, black matte, included fixing set, drain valve, valve cap, white glazed, Ø 84 mm, black matte wall bracket

	<b>Art. No.</b>
matt black / white glossy	4509 800 240

<b>Recommended miscellaneous</b>	<b>Art. No.</b>
Mirror, SP.300	6719 000 899
Mirror, SP.325	6716 000 899
Design mirror, SP.FR375.S1	6740 001 899

**Fittings information**

Impact area approx. 143 – 178 mm from middle tap hole.  
For parameters, see page 20.

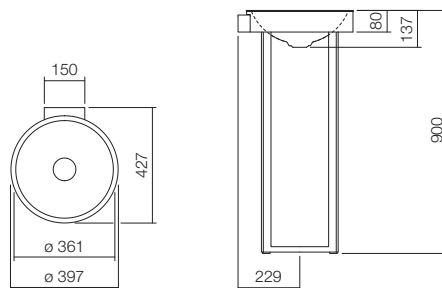
**WT . RX400 . CR**

Washstand, round, w/h/d 397/900/427 mm, sink round, centred, Ø 361 mm, sink depth 137 mm, glazed steel, without tap hole, without overflow, steel bracket, powder finish, black matte, included fixing set, drain valve, valve cap, white glazed, Ø 84 mm, black matte wall bracket

	<b>Art. No.</b>
matt black / white glossy	4509 500 240

<b>Recommended miscellaneous</b>	<b>Art. No.</b>
Mirror, SP.300	6719 000 899
Mirror, SP.325	6716 000 899
Design mirror, SP.FR375.S1	6740 001 899

**Fittings information**

Impact area approx. 138 – 173 mm from rear edge of basin.  
For parameters, see page 20.

**Floor-standing washstands – CU-series – wall-mounted** Mounting and connection measurements > see Page 194

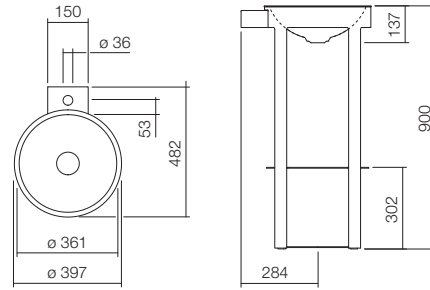
**WT .RX400H .CU**

Washstand, round, w/h/d 397/900/482 mm, sink round, centred, Ø 361 mm, sink depth 137 mm, glazed steel, with one tap hole, without overflow, steel bracket with shelf, powder finish, white, included fixing set, drain valve, valve cap, white glazed, Ø 84 mm, white wall bracket

	Art. No.	Recommended miscellaneous	Art. No.
white, ProShield	4508 800 000	Mirror, SP.300	6719 000 899
		Mirror, SP.325	6716 000 899
		Design mirror, SP.FR375.S1	6740 001 331

**Fittings information**

Impact area approx. 143 – 178 mm from middle tap hole.  
For parameters, see page 20.

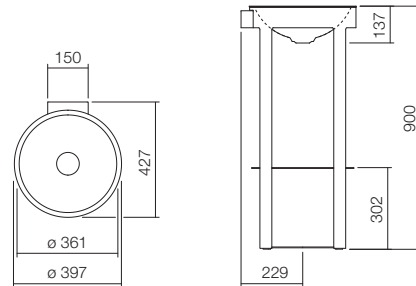
**WT .RX400 .CU**

Washstand, round, w/h/d 397/900/427 mm, sink round, centred, Ø 361 mm, sink depth 137 mm, glazed steel, without tap hole, without overflow, steel bracket with shelf, powder finish, white, included fixing set, drain valve, valve cap, white glazed, Ø 84 mm, white wall bracket

	Art. No.	Recommended miscellaneous	Art. No.
white, ProShield	4508 500 000	Mirror, SP.300	6719 000 899
		Mirror, SP.325	6716 000 899
		Design mirror, SP.FR375.S1	6740 001 331

**Fittings information**

Impact area approx. 138 – 173 mm from rear edge of basin.  
For parameters, see page 20.

**Floor-standing washstands – K-series – wall-mounted**

Mounting and connection measurements &gt; see Page 195

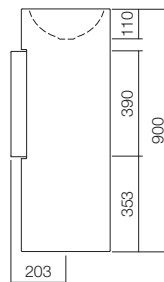
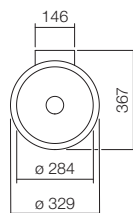
**WT .RX325K**

Washstand, round, w/h/d 329/900/367 mm, sink round, centred,  $\varnothing 284$  mm, sink depth 110 mm, glazed steel, without tap hole, without overflow, included fixing set, drain valve, valve cap, chrome-plated,  $\varnothing 63$  mm, bottle trap, white wall bracket

**Art. No.**

white, ProShield

4501 000 000

**Version**

Glossy, matt, special colour

**Fittings information**

Impact area approx. 125 – 155 mm from rear edge of basin.  
For parameters, see page 20.

**Recommended miscellaneous**

Mirror, SP.300  
Mirror, SP.325

**Art. No.**

6719 000 899  
6716 000 899

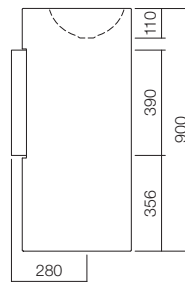
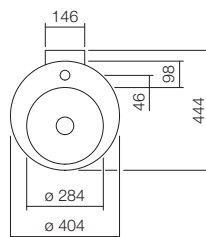
**WT .RX400KH**

Washstand, round, w/h/d 404/900/444 mm, sink round, centred,  $\varnothing 284$  mm, sink depth 110 mm, glazed steel, with one tap hole, without overflow, included fixing set, drain valve, valve cap, chrome-plated,  $\varnothing 63$  mm, bottle trap, white wall bracket

**Art. No.**

white, ProShield

4500 000 000

**Version**

Glossy, matt, special colour

**Fittings information**

Impact area approx. 110 – 140 mm from middle tap hole.  
For parameters, see page 20.

**Recommended miscellaneous**

Mirror, SP.300  
Mirror, SP.325

**Art. No.**

6719 000 899  
6716 000 899



## Floor-standing washstands – K-series – wall-mounted

Mounting and connection measurements > see Page 195

### WT.RX400K

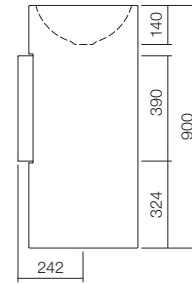
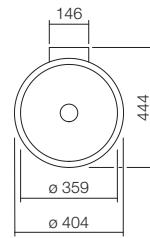

Washstand, round, w/h/d 404/900/444 mm, sink round, centred, Ø 359 mm, sink depth 140 mm, glazed steel, without tap hole, without overflow, included fixing set, drain valve, valve cap, chrome-plated, Ø 63 mm, bottle trap, white wall bracket

#### Art. No.

white, ProShield  
dark iron > see chapter: Special glazes

4503 000 000

#### Version

Glossy, matt, special colour

#### Fittings information

Impact area approx. 152 – 192 mm from rear edge of basin.  
For parameters, see page 20.

#### Recommended miscellaneous

Mirror, SP.300  
Mirror, SP.325

#### Art. No.

6719 000 899  
6716 000 899

**WT . RX400H . CO**

Washstand, round, w/h/d 400/900/500 mm, sink round, centred, Ø 374 mm, sink depth 112 mm, glazed steel, with one tap hole, without overflow, included fixing set, drain valve, valve cap, white glazed, Ø 74 mm, bottle trap, white wall bracket

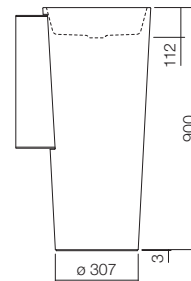
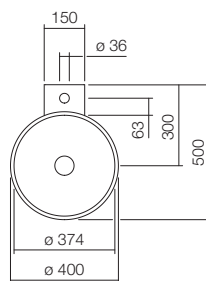
**Art. No.**

white, ProShield

4507 800 000

**Version**

Glossy, matt, special colour

**Fittings information**

Impact area approx. 163 – 198 mm from middle tap hole.  
For parameters, see page 20.

**Recommended miscellaneous**

Mirror, SP.300  
Mirror, SP.325

**Art. No.**

6719 000 899  
6716 000 899

**WT . RX400 . CO**

Washstand, round, w/h/d 400/900/425 mm, sink round, centred, Ø 374 mm, sink depth 112 mm, glazed steel, without tap hole, without overflow, included fixing set, drain valve, valve cap, white glazed, Ø 74 mm, bottle trap, white wall bracket

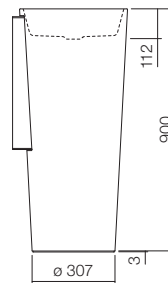
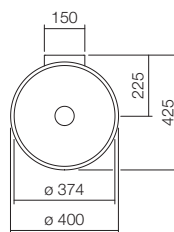
**Art. No.**

white, ProShield

4507 500 000

**Version**

Glossy, matt, special colour

**Fittings information**

Impact area approx. 138 – 173 mm from rear edge of basin.  
For parameters, see page 20.

**Recommended miscellaneous**

Mirror, SP.300  
Mirror, SP.325

**Art. No.**

6719 000 899  
6716 000 899

## Floor-standing washstands – KE-series – wall-mounted

Mounting and connection measurements > see Page 195

### WT . RX325 . KE

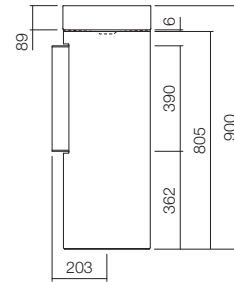
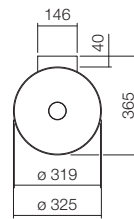

Washstand, round, w/h/d 325/900/365 mm, sink round, centred, Ø 319 mm, sink depth 89 mm, glazed steel, without tap hole, without overflow, included fixing set, drain valve, valve cap, chrome-plated, Ø 63 mm, bottle trap, chrome-plated spacer ring, white wall bracket

#### Art. No.

white, ProShield

4505 500 000

#### Version

Glossy, matt, special colour

#### Fittings information

Impact area approx. 125 – 160 mm from rear edge of basin.  
For parameters, see page 20.

#### Recommended miscellaneous

Mirror, SP.300  
Mirror, SP.325

#### Art. No.

6719 000 899  
6716 000 899

### WT . RX400 . KE

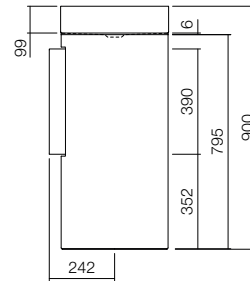
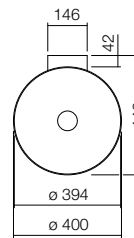

Washstand, round, w/h/d 400/900/442 mm, sink round, centred, Ø 394 mm, sink depth 99 mm, glazed steel, without tap hole, without overflow, included fixing set, drain valve, valve cap, chrome-plated, Ø 74 mm, bottle trap, chrome-plated spacer ring, white wall bracket

#### Art. No.

white, ProShield

4506 500 000

bicolor > see chapter: Special glazes

#### Version

Glossy, matt, special colour

#### Fittings information

Impact area approx. 147 – 192 mm from rear edge of basin.  
For parameters, see page 20.

#### Recommended miscellaneous

Mirror, SP.300  
Mirror, SP.325

#### Art. No.

6719 000 899  
6716 000 899

**Floor-standing washstands – Q-series – wall-mounted**

Mounting and connection measurements &gt; see Page 196

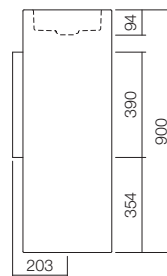
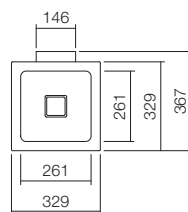
**WT .RX325QS**

Washstand, square, w/h/d 329/900/367 mm, sink square, centred, w/h/d 261/94/261 mm, glazed steel, without tap hole, without overflow, included fixing set, drain valve, valve cap, white glazed, w/d 68/68 mm, bottle trap, white wall bracket

**Art. No.**

white, ProShield

4801 000 000

**Version**

Glossy, matt, special colour

**Fittings information**

Impact area approx. 128 – 148 mm from rear edge of basin.  
For parameters, see page 20.

**Recommended miscellaneous**

Mirror, SP.300  
Mirror, SP.325

**Art. No.**

6719 000 899  
6716 000 899

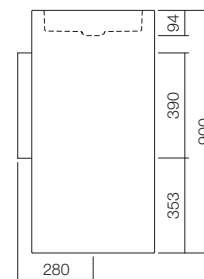
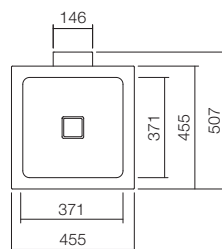
**WT .RX450QS**

Washstand, square, w/h/d 455/900/507 mm, sink square, centred, w/h/d 371/94/371 mm, glazed steel, without tap hole, without overflow, included fixing set, drain valve, valve cap, white glazed, w/d 68/68 mm, bottle trap, white wall bracket

**Art. No.**

white, ProShield

4804 000 000

**Version**

Glossy, matt, special colour

**Fittings information**

Impact area approx. 169 – 224 mm from rear edge of basin.  
For parameters, see page 20.

**Recommended miscellaneous**

Mirror, SP.450  
Mirror, SP.450.4

**Art. No.**

6717 000 899  
6717 004 899

## Floor-standing washstands – K-series – freestanding

Cut-out dimensions: Download [www.alape.com](http://www.alape.com)

### WT . RX325K

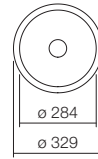

Washstand, round, w/h/d 329/900/329 mm, sink round, centred, Ø 284 mm, sink depth 110 mm, glazed steel, without tap hole, without overflow, included fixing set, drain valve, valve cap, chrome-plated, Ø 63 mm, bottle trap, floor bracket

#### Art. No.

white, ProShield

4502 000 000

#### Version

Glossy, matt, special colour

#### Fittings information

Impact area approx. 87 – 117 mm from rear edge of basin.  
For parameters, see page 20.

### WT . RX400K

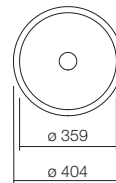

Washstand, round, w/h/d 404/900/404 mm, sink round, centred, Ø 359 mm, sink depth 140 mm, glazed steel, without tap hole, without overflow, included fixing set, drain valve, valve cap, chrome-plated, Ø 63 mm, bottle trap, floor bracket

#### Art. No.

white, ProShield

4504 000 000

#### Version

Glossy, matt, special colour

#### Fittings information

Impact area approx. 112 – 152 mm from rear edge of basin.  
For parameters, see page 20.

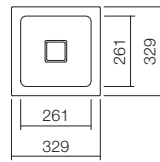
**WT . RX325QS**

Washstand, square, w/h/d 329/902/329 mm, sink square, centred, w/h/d 261/94/261 mm, glazed steel, without tap hole, without overflow, included fixing set, drain valve, valve cap, white glazed, w/d 68/68 mm, bottle trap, floor bracket

**Art. No.**

white, ProShield

4802 000 000

**Version**

Glossy, matt, special colour

**Fittings information**

Impact area approx. 90 – 110 mm from rear edge of basin.  
For parameters, see page 20.

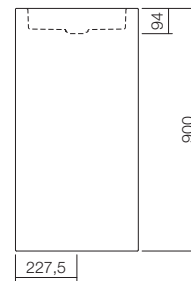
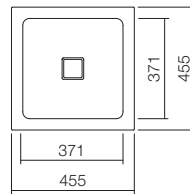
**WT . RX450QS**

Washstand, square, w/h/d 455/900/455 mm, sink square, centred, w/h/d 371/94/371 mm, glazed steel, without tap hole, without overflow, included fixing set, drain valve, valve cap, white glazed, w/d 68/68 mm, bottle trap, floor bracket

**Art. No.**

white, ProShield

4805 000 000

**Version**

Glossy, matt, special colour

**Fittings information**

Impact area approx. 117 – 172 mm from rear edge of basin.  
For parameters, see page 20.

**Washstands – RS-series**

Mounting and connection measurements > see Page 196

**WT . RS325**

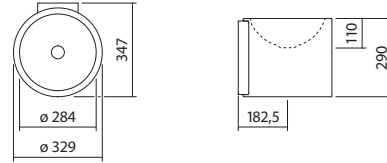

Washstand, round, w/h/d 329/290/347 mm, sink round, centred, Ø 284 mm, sink depth 110 mm, glazed steel, without tap hole, without overflow, included fixing set, white wall bracket

Art. No.
white, ProShield 5041 000 000

Version
Glossy, matt, special colour

Fittings information
Impact area approx. 105 – 135 mm from rear edge of basin. For parameters, see page 20.

Recommended miscellaneous	Art. No.
Bottle trap, Sl.2	8306 000 978
Bottle trap, Sl.3	8312 000 978
Drain valve, VT.2	8304 000 000

**WT . RS400**

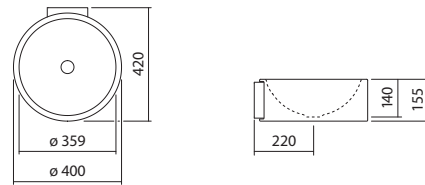

Washstand, round, w/h/d 400/155/420 mm, sink round, centred, Ø 359 mm, sink depth 140 mm, glazed steel, without tap hole, without overflow, included fixing set, white wall bracket

Art. No.
white, ProShield 5052 000 000

Version
Glossy, matt, special colour

Fittings information
Impact area approx. 130 – 170 mm from rear edge of basin. For parameters, see page 20.

Recommended miscellaneous	Art. No.
Bottle trap, Sl.2	8306 000 978
Bottle trap, Sl.3	8312 000 978
Drain valve, VT.3	8305 000 000

**Washstands – RS-series**

Mounting and connection measurements > see Page 196

**WT . RS450**

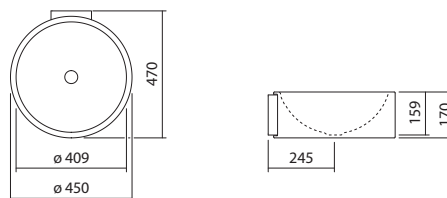

Washstand, round, w/h/d 450/170/470 mm, sink round, centred, Ø 409 mm, sink depth 159 mm, glazed steel, without tap hole, without overflow, included fixing set, white wall bracket

	<b>Art. No.</b>
white, ProShield	5054 000 000

<b>Version</b>	
Glossy, matt, special colour	

<b>Fittings information</b>
Impact area approx. 130 – 190 mm from rear edge of basin. For parameters, see page 20.

<b>Recommended miscellaneous</b>	<b>Art. No.</b>
Bottle trap, Sl.2	8306 000 978
Bottle trap, Sl.3	8312 000 978
Drain valve, VT.3	8305 000 000



**Washstands – CO-series (Scopio)**

Mounting and connection measurements > see Page 196

**WT . C0400H**

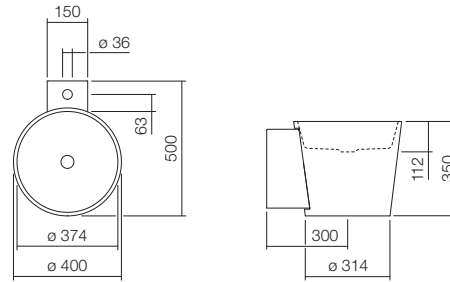

Washstand, round, w/h/d 400/350/500 mm, sink round, centred, Ø 374 mm, sink depth 112 mm, glazed steel, with one tap hole, without overflow, included fixing set, drain valve, valve cap, white glazed, Ø 74 mm, white wall bracket

	<b>Art. No.</b>
white, ProShield	5042 800 000

<b>Version</b>	
Glossy, matt, special colour	

<b>Fittings information</b>
Impact area approx. 163 – 198 mm from middle tap hole. For parameters, see page 20.

<b>Recommended miscellaneous</b>	<b>Art. No.</b>
Bottle trap, Sl.2	8306 000 978
Bottle trap, Sl.3	8312 000 978

**WT . C0400**

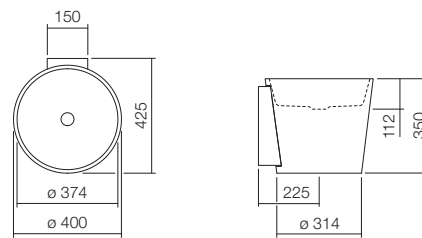

Washstand, round, w/h/d 400/350/425 mm, sink round, centred, Ø 374 mm, sink depth 112 mm, glazed steel, without tap hole, without overflow, included fixing set, drain valve, valve cap, white glazed, Ø 74 mm, white wall bracket

	<b>Art. No.</b>
white, ProShield	5042 500 000

<b>Version</b>	
Glossy, matt, special colour	

<b>Fittings information</b>
Impact area approx. 138 – 173 mm from rear edge of basin. For parameters, see page 20.

<b>Recommended miscellaneous</b>	<b>Art. No.</b>
Bottle trap, Sl.2	8306 000 978
Bottle trap, Sl.3	8312 000 978

**Washstands – IC-series**

Mounting and connection measurements &gt; see Page 197

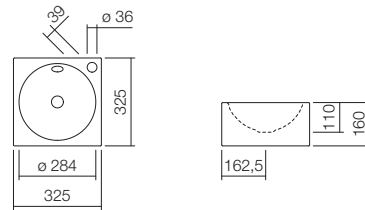
**WT . IC325H**

Washstand, square, w/h/d 325/160/325 mm, sink round, centred, Ø 284 mm, sink depth 110 mm, glazed steel, with one tap hole, with overflow, included fixing set, overflow set

**Art. No.**

white, ProShield

4236 200 000

**Version**

Without overflow  
Glossy, matt, special colour

**Fittings information**

Impact area approx. 104 – 134 mm from middle tap hole.  
For parameters, see page 20.

**Recommended miscellaneous****Art. No.**

Bottle trap, Sl.2	8306 000 978
Bottle trap, Sl.3	8312 000 978
Drain valve, VT.1	8302 000 978
Angle valve cover, EV.3	8110 000 978

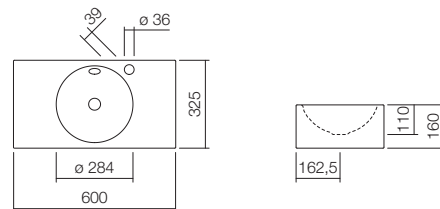
**WT . IC600H**

Washstand, rectangular, w/h/d 600/160/325 mm, sink round, centred, Ø 284 mm, sink depth 110 mm, glazed steel, with one tap hole, with overflow, included fixing set, overflow set

**Art. No.**

white, ProShield

4238 200 000

**Version**

Without tap hole  
Without overflow  
Glossy, matt, special colour

**Fittings information**

Impact area approx. 104 – 134 mm from middle tap hole.  
For parameters, see page 20.

**Recommended miscellaneous****Art. No.**

Bottle trap, Sl.2	8306 000 978
Bottle trap, Sl.3	8312 000 978
Drain valve, VT.1	8302 000 978
Angle valve cover, EV.3	8110 000 978

## Washstands – IC-series

Mounting and connection measurements > see Page 197

### WT . IC600H . L

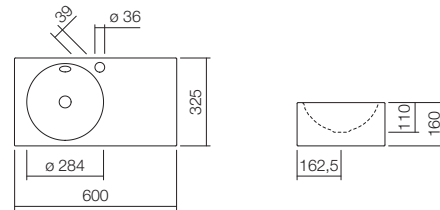

Washstand, rectangular, w/h/d 600/160/325 mm, sink round, left, Ø 284 mm, sink depth 110 mm, glazed steel, with one tap hole, with overflow, included fixing set, overflow set

Art. No.
white, ProShield 4239 200 000

Version
Without tap hole
Without overflow
Glossy, matt, special colour

#### Fittings information

Impact area approx. 104 – 134 mm from middle tap hole.  
For parameters, see page 20.

Recommended miscellaneous	Art. No.
Bottle trap, Sl.2	8306 000 978
Bottle trap, Sl.3	8312 000 978
Drain valve, VT.1	8302 000 978
Angle valve cover, EV.3	8110 000 978

### WT . IC600H . R

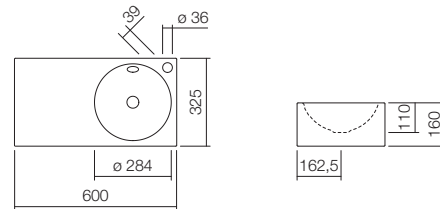

Washstand, rectangular, w/h/d 600/160/325 mm, sink round, right, Ø 284 mm, sink depth 110 mm, glazed steel, with one tap hole, with overflow, included fixing set, overflow set

Art. No.
white, ProShield 4240 200 000

Version
Without tap hole
Without overflow
Glossy, matt, special colour

#### Fittings information

Impact area approx. 104 – 134 mm from middle tap hole.  
For parameters, see page 20.

Recommended miscellaneous	Art. No.
Bottle trap, Sl.2	8306 000 978
Bottle trap, Sl.3	8312 000 978
Drain valve, VT.1	8302 000 978
Angle valve cover, EV.3	8110 000 978

**Washstands – MC-series**

Mounting and connection measurements &gt; see Page 197

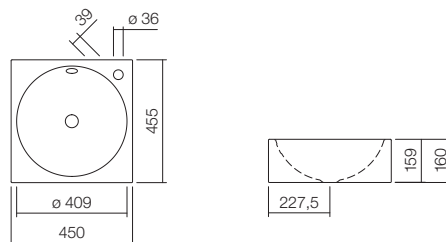
**WT . MC450H**

Washstand, rectangular, w/h/d 450/160/455 mm, sink round, centred,  $\varnothing 409$  mm, sink depth 159 mm, glazed steel, with one tap hole, with overflow, included fixing set, overflow set

**Art. No.**

white, ProShield

4228 000 000

**Version**

Without overflow  
Glossy, matt, special colour

**Fittings information**

Impact area approx. 129 – 189 mm from middle tap hole.  
For parameters, see page 20.

**Recommended miscellaneous****Art. No.**

Bottle trap, Sl.2	8306 000 978
Bottle trap, Sl.3	8312 000 978
Drain valve, VT.1	8302 000 978
Angle valve cover, EV.3	8110 000 978

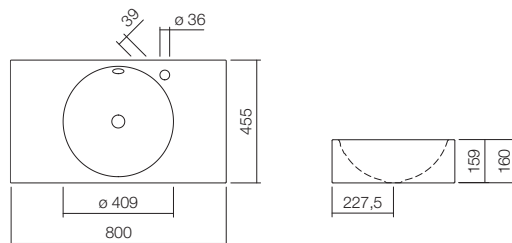
**WT . MC800H**

Washstand, rectangular, w/h/d 800/160/455 mm, sink round, centred,  $\varnothing 409$  mm, sink depth 159 mm, glazed steel, with one tap hole, with overflow, included fixing set, overflow set

**Art. No.**

white, ProShield

4230 000 000

**Version**

Without overflow  
Glossy, matt, special colour

**Fittings information**

Impact area approx. 129 – 189 mm from middle tap hole.  
For parameters, see page 20.

**Recommended miscellaneous****Art. No.**

Bottle trap, Sl.2	8306 000 978
Bottle trap, Sl.3	8312 000 978
Drain valve, VT.1	8302 000 978
Angle valve cover, EV.3	8110 000 978

## Washstands – MC-series

Mounting and connection measurements > see Page 197

### WT . MC800H . L



Washstand, rectangular, w/h/d 800/160/455 mm, sink round, left, Ø 409 mm, sink depth 159 mm, glazed steel, with one tap hole, with overflow, included fixing set, overflow set

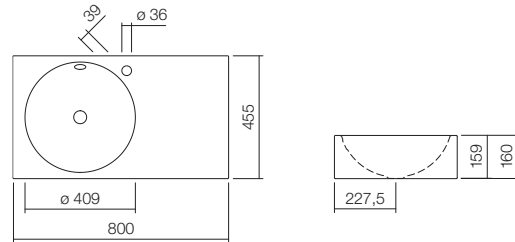

Art. No.
white, ProShield 4231 000 000

Version
Without tap hole
Without overflow
Glossy, matt, special colour

#### Fittings information

Impact area approx. 129 – 189 mm from middle tap hole.  
For parameters, see page 20.

Recommended miscellaneous	Art. No.
Bottle trap, Sl.2	8306 000 978
Bottle trap, Sl.3	8312 000 978
Drain valve, VT.1	8302 000 978
Angle valve cover, EV.3	8110 000 978

### WT . MC800H . R



Washstand, rectangular, w/h/d 800/160/455 mm, sink round, right, Ø 409 mm, sink depth 159 mm, glazed steel, with one tap hole, with overflow, included fixing set, overflow set

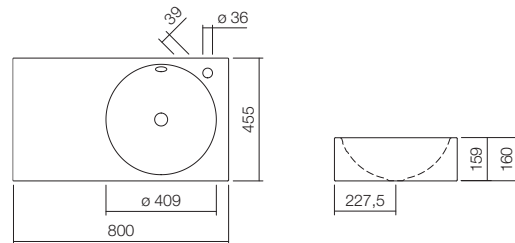

Art. No.
white, ProShield 4232 000 000

Version
Without tap hole
Without overflow
Glossy, matt, special colour

#### Fittings information

Impact area approx. 129 – 189 mm from middle tap hole.  
For parameters, see page 20.

Recommended miscellaneous	Art. No.
Bottle trap, Sl.2	8306 000 978
Bottle trap, Sl.3	8312 000 978
Drain valve, VT.1	8302 000 978
Angle valve cover, EV.3	8110 000 978

**Washstands – XXS-series (Fusion.S)**

Mounting and connection measurements &gt; see Page 198

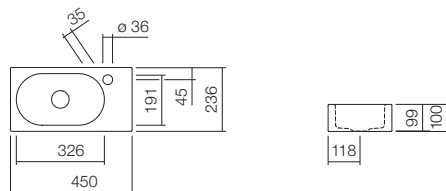
**WT . XXS450H . L**

Washstand, rectangular, w/h/d 450/100/236 mm, sink oval, left, w/h/d 326/99/191 mm, glazed steel, with one tap hole, without overflow, included fixing set, drain valve, valve cap, chrome-plated, Ø 63 mm

**Art. No.**

white, ProShield

4295 000 000

**Version**

Glossy, matt, special colour

**Fittings information**

Impact area approx. 70 – 145 mm from middle tap hole.  
For parameters, see page 20.

**Recommended miscellaneous**

Bottle trap, Sl.2  
Bottle trap, Sl.3  
Angle valve cover, EV.3

**Art. No.**

8306 000 978  
8312 000 978  
8110 000 978

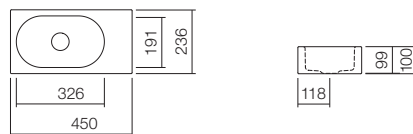
**WT . XXS450 . L**

Washstand, rectangular, w/h/d 450/100/236 mm, sink oval, left, w/h/d 326/99/191 mm, glazed steel, without tap hole, without overflow, included fixing set, drain valve, valve cap, chrome-plated, Ø 63 mm

**Art. No.**

white, ProShield

4296 000 000

**Version**

Glossy, matt, special colour

**Fittings information**

Impact area approx. 60 – 75 mm from rear edge of basin.  
For parameters, see page 20.

**Recommended miscellaneous**

Bottle trap, Sl.2  
Bottle trap, Sl.3

**Art. No.**

8306 000 978  
8312 000 978

**Washstands – XXS-series (Fusion.S)**

Mounting and connection measurements &gt; see Page 198

**WT . XXS450H . R**

Washstand, rectangular, w/h/d 450/100/236 mm, sink oval, right, w/h/d 326/99/191 mm, glazed steel, with one tap hole, without overflow, included fixing set, drain valve, valve cap, chrome-plated, Ø 63 mm

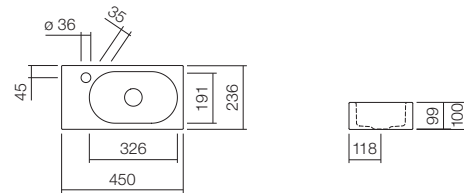

Art. No.
white, ProShield
4297 000 000

Version
Glossy, matt, special colour

**Fittings information**

Impact area approx. 70 – 145 mm from middle tap hole.  
For parameters, see page 20.

Recommended miscellaneous	Art. No.
Bottle trap, Sl.2	8306 000 978
Bottle trap, Sl.3	8312 000 978
Angle valve cover, EV.3	8110 000 978

**WT . XXS450 . R**

Washstand, rectangular, w/h/d 450/100/236 mm, sink oval, right, w/h/d 326/99/191 mm, glazed steel, without tap hole, without overflow, included fixing set, drain valve, valve cap, chrome-plated, Ø 63 mm

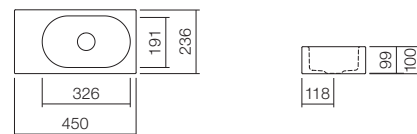

Art. No.
white, ProShield
4298 000 000

Version
Glossy, matt, special colour

**Fittings information**

Impact area approx. 60 – 75 mm from rear edge of basin.  
For parameters, see page 20.

Recommended miscellaneous	Art. No.
Bottle trap, Sl.2	8306 000 978
Bottle trap, Sl.3	8312 000 978

## Washstands – Q-series

Mounting and connection measurements &gt; see Page 199

## WT . QS325H

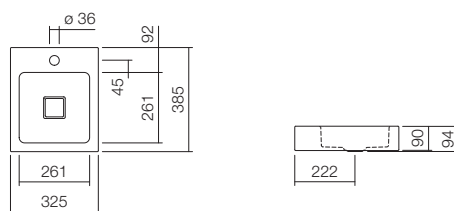

Washstand, rectangular, w/h/d 325/94/385 mm, sink square, centred, w/h/d 261/90/261 mm, glazed steel, with one tap hole, without overflow, included fixing set, drain valve, valve cap, white glazed, w/d 68/68 mm

**Art. No.**

white, ProShield

4277 000 000

**Version**

Without tap hole  
3 Drill holes  
Drill hole for lotion dispenser  
Glossy, matt, special colour

**Fittings information**

Impact area approx. 100 – 120 mm from middle tap hole.  
For parameters, see page 20.

**Recommended miscellaneous****Art. No.**

Bottle trap, Sl.2	8306 000 978
Bottle trap, Sl.3	8312 000 978
Angle valve cover, EV.3	8110 000 978

## WT . QS325

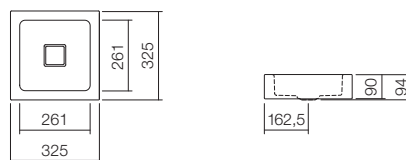

Washstand, square, w/h/d 325/94/325 mm, sink square, centred, w/h/d 261/90/261 mm, glazed steel, without tap hole, without overflow, included fixing set, drain valve, valve cap, white glazed, w/d 68/68 mm

**Art. No.**

white, ProShield

4270 000 000

**Version**

Glossy, matt, special colour

**Fittings information**

Impact area approx. 88 – 108 mm from rear edge of basin.  
For parameters, see page 20.

**Recommended miscellaneous****Art. No.**

Bottle trap, Sl.2	8306 000 978
Bottle trap, Sl.3	8312 000 978



## Washstands – Q-series

Mounting and connection measurements > see Page 199

### WT . QS325X

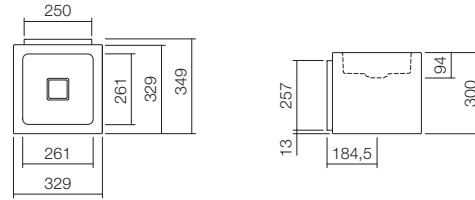

Washstand, square, w/h/d 329/300/349 mm, sink square, centred, w/h/d 261/94/261 mm, glazed steel, without tap hole, without overflow, included fixing set, drain valve, valve cap, white glazed, w/d 68/68 mm

#### Art. No.

white, ProShield

4271 000 000

#### Version

Glossy, matt, special colour

#### Fittings information

Impact area approx. 110 – 130 mm from rear edge of basin.  
For parameters, see page 20.

#### Recommended miscellaneous

Bottle trap, Sl.2  
Bottle trap, Sl.3

#### Art. No.

8306 000 978  
8312 000 978

### WT . QS450HX

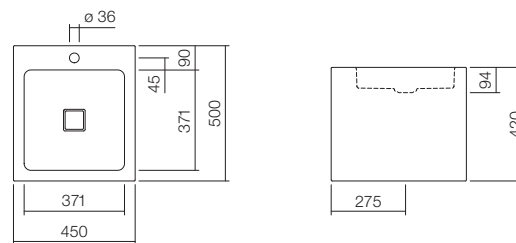

Washstand, rectangular, w/h/d 450/420/500 mm, sink square, centred, w/h/d 371/94/371 mm, glazed steel, with one tap hole, without overflow, included fixing set, drain valve, valve cap, white glazed, w/d 68/68 mm

#### Art. No.

white, ProShield

4278 000 000

#### Version

Without tap hole  
3 Drill holes  
Drill hole for lotion dispenser  
Glossy, matt, special colour

#### Fittings information

Impact area approx. 120 – 175 mm from middle tap hole.  
For parameters, see page 20.

#### Recommended miscellaneous

Bottle trap, Sl.3  
Bottle trap, Sl.2

#### Art. No.

8312 000 978  
8306 000 978

**Washstands – Q-series**

Mounting and connection measurements &gt; see Page 199

**WT . QS450H**

Washstand, rectangular, w/h/d 450/110/500 mm, sink square, centred, w/h/d 371/94/371 mm, glazed steel, with one tap hole, without overflow, included fixing set, drain valve, valve cap, white glazed, w/d 68/68 mm

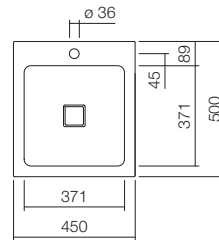

	<b>Art. No.</b>
white, ProShield	4276 000 000

**Version**  
 Without tap hole  
 3 Drill holes  
 Drill hole for lotion dispenser  
 Glossy, matt, special colour

**Fittings information**

Impact area approx. 120 – 175 mm from middle tap hole.  
 For parameters, see page 20.

<b>Recommended miscellaneous</b>	<b>Art. No.</b>
Bottle trap, Sl.2	8306 000 978
Bottle trap, Sl.3	8312 000 978
Angle valve cover, EV.3	8110 000 978

**WT . QS450**

Washstand, square, w/h/d 450/110/450 mm, sink square, centred, w/h/d 371/94/371 mm, glazed steel, without tap hole, without overflow, included fixing set, drain valve, valve cap, white glazed, w/d 68/68 mm

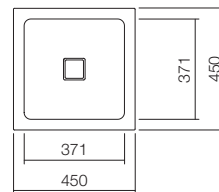

	<b>Art. No.</b>
white, ProShield	4275 000 000

**Version**  
 Glossy, matt, special colour

**Fittings information**

Impact area approx. 115 – 170 mm from rear edge of basin.  
 For parameters, see page 20.

<b>Recommended miscellaneous</b>	<b>Art. No.</b>
Bottle trap, Sl.2	8306 000 978
Bottle trap, Sl.3	8312 000 978

## Washstands – Q-series

Mounting and connection measurements > see Page 199

### WT . QS525H . L

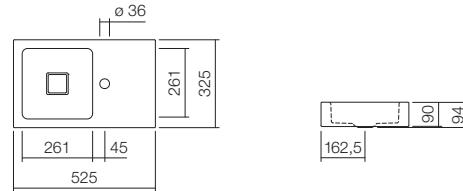

Washstand, rectangular, w/h/d 525/94/325 mm, sink square, left, w/h/d 261/90/261 mm, glazed steel, with one tap hole, without overflow, included fixing set, drain valve, valve cap, white glazed, w/d 68/68 mm

#### Art. No.

white, ProShield

4279 000 000

#### Version

Glossy, matt, special colour

#### Fittings information

Impact area approx. 100 – 120 mm from middle tap hole.  
For parameters, see page 20.

#### Recommended miscellaneous

Bottle trap, Sl.2  
Bottle trap, Sl.3  
Angle valve cover, EV.3

#### Art. No.

8306 000 978  
8312 000 978  
8110 000 978

### WT . QS525 . L

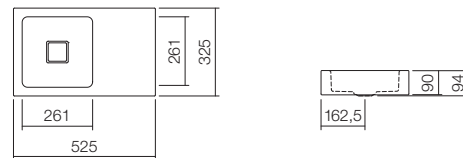

Washstand, rectangular, w/h/d 525/94/325 mm, sink square, left, w/h/d 261/90/261 mm, glazed steel, without tap hole, without overflow, included fixing set, drain valve, valve cap, white glazed, w/d 68/68 mm

#### Art. No.

white, ProShield

4273 000 000

#### Version

Glossy, matt, special colour

#### Fittings information

Impact area approx. 88 – 108 mm from rear edge of basin.  
For parameters, see page 20.

#### Recommended miscellaneous

Bottle trap, Sl.2  
Bottle trap, Sl.3

#### Art. No.

8306 000 978  
8312 000 978

**Washstands – Q-series**

Mounting and connection measurements &gt; see Page 199

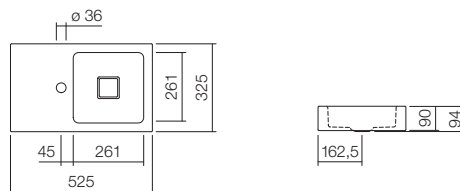
**WT . QS525H . R**

Washstand, rectangular, w/h/d 525/94/325 mm, sink square, right, w/h/d 261/90/261 mm, glazed steel, with one tap hole, without overflow, included fixing set, drain valve, valve cap, white glazed, w/d 68/68 mm

**Art. No.**

white, ProShield

4280 000 000

**Version**

Glossy, matt, special colour

**Fittings information**

Impact area approx. 100 – 120 mm from middle tap hole.  
For parameters, see page 20.

**Recommended miscellaneous**

Bottle trap, Sl.2  
Bottle trap, Sl.3  
Angle valve cover, EV.3

**Art. No.**

8306 000 978  
8312 000 978  
8110 000 978

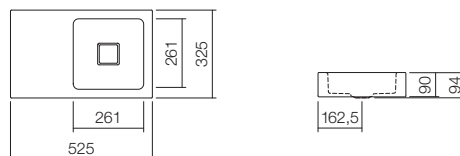
**WT . QS525 . R**

Washstand, rectangular, w/h/d 525/94/325 mm, sink square, right, w/h/d 261/90/261 mm, glazed steel, without tap hole, without overflow, included fixing set, drain valve, valve cap, white glazed, w/d 68/68 mm

**Art. No.**

white, ProShield

4274 000 000

**Version**

Glossy, matt, special colour

**Fittings information**

Impact area approx. 88 – 108 mm from rear edge of basin.  
For parameters, see page 20.

**Recommended miscellaneous**

Bottle trap, Sl.2  
Bottle trap, Sl.3

**Art. No.**

8306 000 978  
8312 000 978

**Washstands – XS-series (X.plore.S)**

Mounting and connection measurements &gt; see Page 198

**WT . XS500H . L**

Washstand, rectangular, w/h/d 500/100/268 mm, sink rectangular, left, w/h/d 345/95/215 mm, glazed steel, with one tap hole, without overflow, included fixing set, drain valve, valve cap, white glazed, w/d 68/68 mm

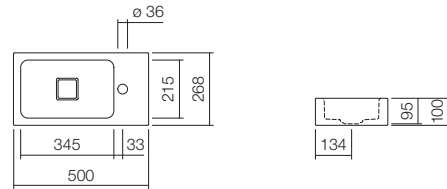

	<b>Art. No.</b>
white, ProShield	4290 000 000

<b>Version</b>	
Glossy, matt, special colour	

**Fittings information**

Impact area approx. 110 – 205 mm from middle tap hole.  
For parameters, see page 20.

<b>Recommended miscellaneous</b>	<b>Art. No.</b>
Bottle trap, Sl.2	8306 000 978
Bottle trap, Sl.3	8312 000 978
Angle valve cover, EV.3	8110 000 978

**WT . XS500 . L**

Washstand, rectangular, w/h/d 500/100/268 mm, sink rectangular, left, w/h/d 345/95/215 mm, glazed steel, without tap hole, without overflow, included fixing set, drain valve, valve cap, white glazed, w/d 68/68 mm

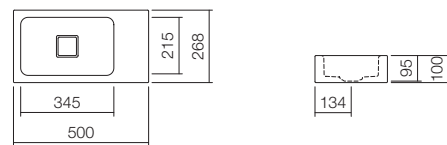

	<b>Art. No.</b>
white, ProShield	4291 000 000

<b>Version</b>	
Glossy, matt, special colour	

**Fittings information**

Impact area approx. 75 – 135 mm from rear edge of basin.  
For parameters, see page 20.

<b>Recommended miscellaneous</b>	<b>Art. No.</b>
Bottle trap, Sl.2	8306 000 978
Bottle trap, Sl.3	8312 000 978

**Washstands – XS-series (X.plore.S)**

Mounting and connection measurements &gt; see Page 198

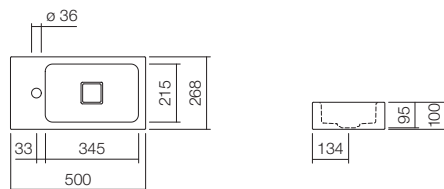
**WT . XS500H . R**

Washstand, rectangular, w/h/d 500/100/268 mm, sink rectangular, right, w/h/d 345/95/215 mm, glazed steel, with one tap hole, without overflow, included fixing set, drain valve, valve cap, white glazed, w/d 68/68 mm

**Art. No.**

white, ProShield

4292 000 000

**Version**

Glossy, matt, special colour

**Fittings information**

Impact area approx. 110 – 205 mm from middle tap hole.  
For parameters, see page 20.

**Recommended miscellaneous**

Bottle trap, Sl.2  
Bottle trap, Sl.3  
Angle valve cover, EV.3

**Art. No.**

8306 000 978  
8312 000 978  
8110 000 978

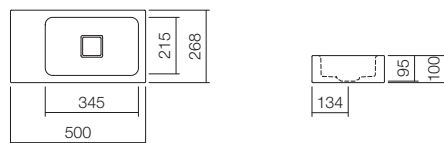
**WT . XS500 . R**

Washstand, rectangular, w/h/d 500/100/268 mm, sink rectangular, right, w/h/d 345/95/215 mm, glazed steel, without tap hole, without overflow, included fixing set, drain valve, valve cap, white glazed, w/d 68/68 mm

**Art. No.**

white, ProShield

4293 000 000

**Version**

Glossy, matt, special colour

**Fittings information**

Impact area approx. 75 – 135 mm from rear edge of basin.  
For parameters, see page 20.

**Recommended miscellaneous**

Bottle trap, Sl.2  
Bottle trap, Sl.3

**Art. No.**

8306 000 978  
8312 000 978

## Washstands – SR-series (Stream)

Mounting and connection measurements > see Page 200

### WT . SR800H . L



Washstand, rectangular, w/h/d 800/127/472 mm, sink rectangular, left, w/h/d 609/100/359 mm, glazed steel, with one tap hole, with overflow, included fixing set, overflow set

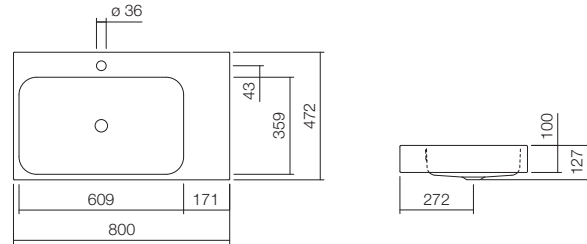

	Art. No.
white, ProShield	4281 600 000

#### Fittings information

Impact area approx. 105 – 155 mm from middle tap hole.  
For parameters, see page 20.

Version	Art. No.
Without tap hole	
Without overflow	
3 Drill holes	
Drill hole for lotion dispenser	
Glossy, matt, special colour	
Recommended miscellaneous	Art. No.
Bottle trap, Sl.2	8306 000 978
Bottle trap, Sl.3	8312 000 978
Drain valve, VT.1	8302 000 978
Angle valve cover, EV.3	8110 000 978

### WT . SR800H . R



Washstand, rectangular, w/h/d 800/127/472 mm, sink rectangular, right, w/h/d 609/100/359 mm, glazed steel, with one tap hole, with overflow, included fixing set, overflow set

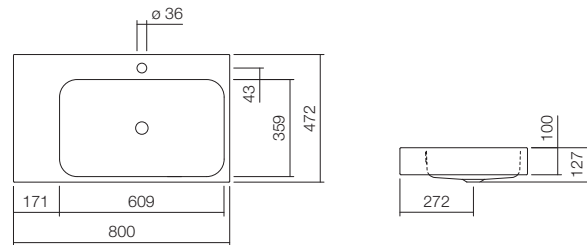

	Art. No.
white, ProShield	4282 600 000

#### Fittings information

Impact area approx. 105 – 155 mm from middle tap hole.  
For parameters, see page 20.

Version	Art. No.
Without tap hole	
Without overflow	
3 Drill holes	
Drill hole for lotion dispenser	
Glossy, matt, special colour	
Recommended miscellaneous	Art. No.
Bottle trap, Sl.2	8306 000 978
Bottle trap, Sl.3	8312 000 978
Drain valve, VT.1	8302 000 978
Angle valve cover, EV.3	8110 000 978

## Washstands – PR-series

Mounting and connection measurements > see Page 200

### WT . PR585H

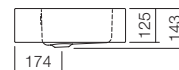
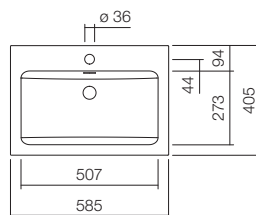

Washstand, rectangular, w/h/d 585/143/405 mm, sink rectangular, centred, w/h/d 507/125/273 mm, glazed steel, with one tap hole, with overflow, included fixing set, overflow set

#### Art. No.

white, ProShield

4201 000 000

#### Version

Without tap hole  
Without overflow  
3 Drill holes  
Drill hole for lotion dispenser  
Glossy, matt, special colour

#### Fittings information

Impact area approx. 168 – 188 mm from middle tap hole.  
For parameters, see page 20.

#### Recommended miscellaneous

#### Art. No.

Bottle trap, Sl.2	8306 000 978
Bottle trap, Sl.3	8312 000 978
Drain valve, VT.1	8302 000 978
Angle valve cover, EV.3	8110 000 978

### WT . PR585

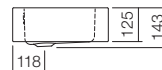
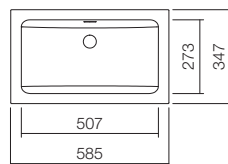

Washstand, rectangular, w/h/d 585/143/347 mm, sink rectangular, centred, w/h/d 507/125/273 mm, glazed steel, without tap hole, with overflow, included fixing set, overflow set

#### Art. No.

white, ProShield

4200 000 000

#### Version

Without overflow  
Glossy, matt, special colour

#### Fittings information

Impact area approx. 162 – 182 mm from rear edge of basin.  
For parameters, see page 20.

#### Recommended miscellaneous

#### Art. No.

Bottle trap, Sl.2	8306 000 978
Bottle trap, Sl.3	8312 000 978
Drain valve, VT.1	8302 000 978



## Washstands – PR-series

Mounting and connection measurements > see Page 200

### WT . PR800H

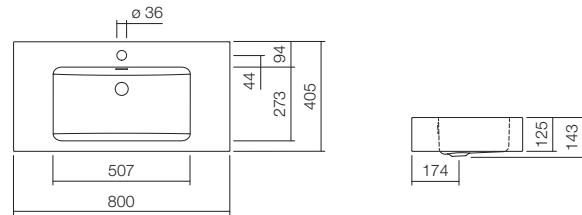

Washstand, rectangular, w/h/d 800/143/405 mm, sink rectangular, centred, w/h/d 507/125/273 mm, glazed steel, with one tap hole, with overflow, included fixing set, overflow set

	Art. No.
white, ProShield	4203 000 000

Version
Without overflow
3 Drill holes
Drill hole for lotion dispenser
Glossy, matt, special colour

#### Fittings information

Impact area approx. 168 – 188 mm from middle tap hole.  
For parameters, see page 20.

Recommended miscellaneous	Art. No.
Bottle trap, Sl.2	8306 000 978
Bottle trap, Sl.3	8312 000 978
Drain valve, VT.1	8302 000 978
Angle valve cover, EV.3	8110 000 978

### WT . PR800

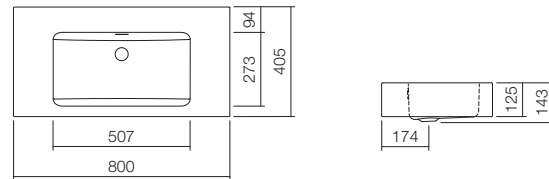

Washstand, rectangular, w/h/d 800/143/405 mm, sink rectangular, centred, w/h/d 507/125/273 mm, glazed steel, without tap hole, with overflow, included fixing set, overflow set

	Art. No.
white, ProShield	4203 300 000

Version
Without overflow
3 Drill holes
Drill hole for lotion dispenser
Glossy, matt, special colour

#### Fittings information

Impact area approx. 218 – 238 mm from rear edge of basin.  
For parameters, see page 20.

Recommended miscellaneous	Art. No.
Bottle trap, Sl.2	8306 000 978
Bottle trap, Sl.3	8312 000 978
Drain valve, VT.1	8302 000 978

**Washstands – PR-series**

Mounting and connection measurements &gt; see Page 200/201

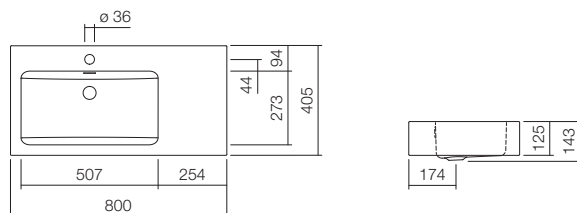
**WT . PR800H . L**

Washstand, rectangular, w/h/d 800/143/405 mm, sink rectangular, left, w/h/d 507/125/273 mm, glazed steel, with one tap hole, with overflow, included fixing set, overflow set

**Art. No.**

white, ProShield

4205 000 000

**Version**

Without overflow  
3 Drill holes  
Drill hole for lotion dispenser  
Glossy, matt, special colour

**Fittings information**

Impact area approx. 168 – 188 mm from middle tap hole.  
For parameters, see page 20.

**Recommended miscellaneous****Art. No.**

Bottle trap, Sl.2	8306 000 978
Bottle trap, Sl.3	8312 000 978
Drain valve, VT.1	8302 000 978
Angle valve cover, EV.3	8110 000 978

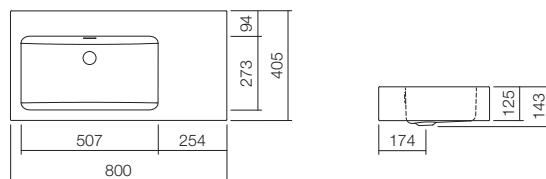
**WT . PR800 . L**

Washstand, rectangular, w/h/d 800/143/405 mm, sink rectangular, left, w/h/d 507/125/273 mm, glazed steel, without tap hole, with overflow, included fixing set, overflow set

**Art. No.**

white, ProShield

4205 300 000

**Version**

Without overflow  
3 Drill holes  
Drill hole for lotion dispenser  
Glossy, matt, special colour

**Fittings information**

Impact area approx. 218 – 238 mm from rear edge of basin.  
For parameters, see page 20.

**Recommended miscellaneous****Art. No.**

Bottle trap, Sl.2	8306 000 978
Bottle trap, Sl.3	8312 000 978
Drain valve, VT.1	8302 000 978

## Washstands – PR-series

Mounting and connection measurements > see Page 200/201

### WT . PR800H . R



Washstand, rectangular, w/h/d 800/143/405 mm, sink rectangular, right, w/h/d 507/125/273 mm, glazed steel, with one tap hole, with overflow, included fixing set, overflow set

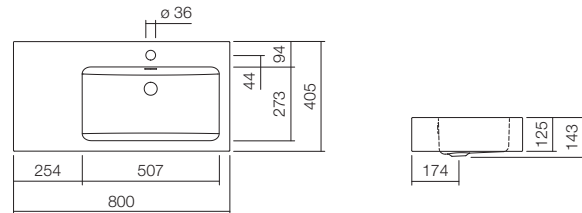

	Art. No.
white, ProShield	4207 000 000

#### Fittings information

Impact area approx. 168 – 188 mm from middle tap hole.  
For parameters, see page 20.

Version
Without overflow
3 Drill holes
Drill hole for lotion dispenser
Glossy, matt, special colour

Recommended miscellaneous	Art. No.
Bottle trap, Sl.2	8306 000 978
Bottle trap, Sl.3	8312 000 978
Drain valve, VT.1	8302 000 978
Angle valve cover, EV.3	8110 000 978

### WT . PR800 . R



Washstand, rectangular, w/h/d 800/143/405 mm, sink rectangular, right, w/h/d 507/125/273 mm, glazed steel, without tap hole, with overflow, included fixing set, overflow set

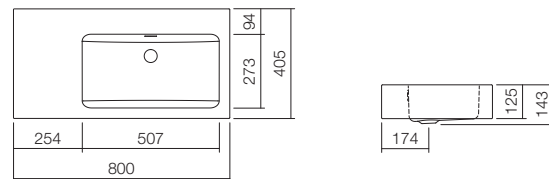

	Art. No.
white, ProShield	4207 300 000

#### Fittings information

Impact area approx. 218 – 238 mm from rear edge of basin.  
For parameters, see page 20.

Version
Without overflow
3 Drill holes
Drill hole for lotion dispenser
Glossy, matt, special colour

Recommended miscellaneous	Art. No.
Bottle trap, Sl.2	8306 000 978
Bottle trap, Sl.3	8312 000 978
Drain valve, VT.1	8302 000 978

**Washstands – GR-series**

Mounting and connection measurements &gt; see Page 201

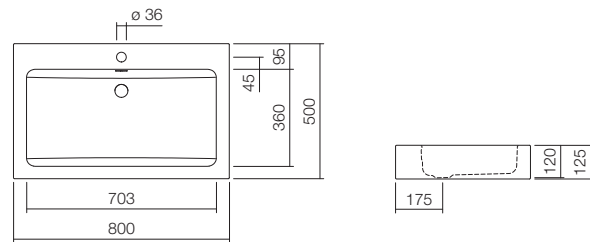
**WT . GR800H**

Washstand, rectangular, w/h/d 800/125/500 mm, sink rectangular, centred, w/h/d 703/120/360 mm, glazed steel, with one tap hole, with overflow, included fixing set, overflow set

	<b>Art. No.</b>
white, ProShield	4261 200 000

**Fittings information**

Impact area approx. 185 – 240 mm from middle tap hole.  
For parameters, see page 20.

<b>Version</b>	
Without tap hole	
Without overflow	
3 Drill holes	
Drill hole for lotion dispenser	
Glossy, matt, special colour	

<b>Recommended miscellaneous</b>	<b>Art. No.</b>
Bottle trap, Sl.2	8306 000 978
Bottle trap, Sl.3	8312 000 978
Drain valve, VT.1	8302 000 978
Angle valve cover, EV.3	8110 000 978

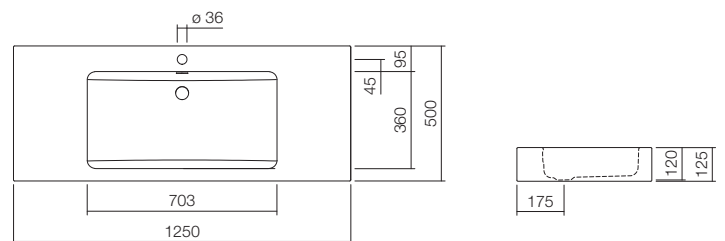
**WT . GR1250H**

Washstand, rectangular, w/h/d 1250/125/500 mm, sink rectangular, centred, w/h/d 703/120/360 mm, glazed steel, with one tap hole, with overflow, included fixing set, overflow set

	<b>Art. No.</b>
white, ProShield	4287 200 000

**Fittings information**

Impact area approx. 185 – 240 mm from middle tap hole.  
For parameters, see page 20.

<b>Version</b>	
Without tap hole	
Without overflow	
3 Drill holes	
Drill hole for lotion dispenser	
Glossy, matt, special colour	

<b>Recommended miscellaneous</b>	<b>Art. No.</b>
Bottle trap, Sl.2	8306 000 978
Bottle trap, Sl.3	8312 000 978
Drain valve, VT.1	8302 000 978
Angle valve cover, EV.3	8110 000 978

## Washstands – GR-series

Mounting and connection measurements > see Page 201

### WT . GR1250H . L



Washstand, rectangular, w/h/d 1250/125/500 mm, sink rectangular, left, w/h/d 703/120/360 mm, glazed steel, with one tap hole, with overflow, included fixing set, overflow set

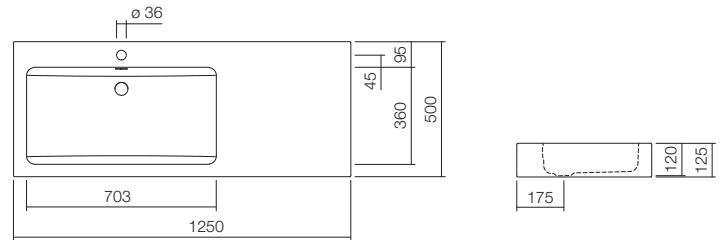

	Art. No.
white, ProShield	4288 200 000

#### Fittings information

Impact area approx. 185 – 240 mm from middle tap hole.  
For parameters, see page 20.

Version	Art. No.
Without tap hole	
Without overflow	
3 Drill holes	
Drill hole for lotion dispenser	
Glossy, matt, special colour	
Recommended miscellaneous	Art. No.
Bottle trap, Sl.2	8306 000 978
Bottle trap, Sl.3	8312 000 978
Drain valve, VT.1	8302 000 978
Angle valve cover, EV.3	8110 000 978

### WT . GR1250H . R



Washstand, rectangular, w/h/d 1250/125/500 mm, sink rectangular, right, w/h/d 703/120/360 mm, glazed steel, with one tap hole, with overflow, included fixing set, overflow set

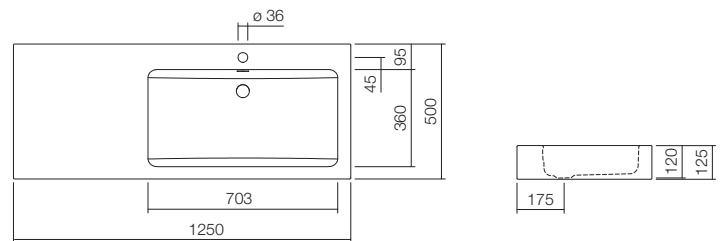

	Art. No.
white, ProShield	4289 200 000

#### Fittings information

Impact area approx. 185 – 240 mm from middle tap hole.  
For parameters, see page 20.

Version	Art. No.
Without tap hole	
Without overflow	
3 Drill holes	
Drill hole for lotion dispenser	
Glossy, matt, special colour	
Recommended miscellaneous	Art. No.
Bottle trap, Sl.2	8306 000 978
Bottle trap, Sl.3	8312 000 978
Drain valve, VT.1	8302 000 978
Angle valve cover, EV.3	8110 000 978

**Washstands – RE-series (X.plicit)**

Mounting and connection measurements &gt; see Page 201

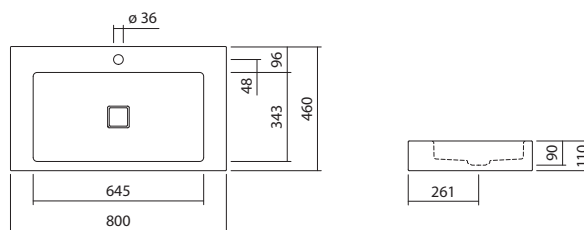
**WT . RE800H**

Washstand, rectangular, w/h/d 800/110/460 mm, sink rectangular, centred, w/h/d 632/90/330 mm, glazed steel, with one tap hole, without overflow, included fixing set, drain valve, valve cap, white glazed, w/d 68/68 mm

	<b>Art. No.</b>
white, ProShield	4105 000 000

<b>Version</b>	
3 Drill holes	
Drill hole for lotion dispenser	
Glossy, matt, special colour	

**Fittings information**

Impact area approx. 120 – 150 mm from middle tap hole.  
For parameters, see page 20.

<b>Recommended miscellaneous</b>	<b>Art. No.</b>
Bottle trap, Sl.2	8306 000 978
Bottle trap, Sl.3	8312 000 978
Angle valve cover, EV.3	8110 000 978

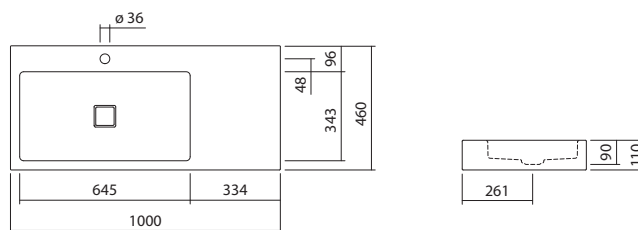
**WT . RE1000H . L**

Washstand, rectangular, w/h/d 1000/110/460 mm, sink rectangular, left, w/h/d 645/90/343 mm, glazed steel, with one tap hole, without overflow, included fixing set, drain valve, valve cap, white glazed, w/d 68/68 mm

	<b>Art. No.</b>
white, ProShield	4102 000 000

<b>Version</b>	
3 Drill holes	
Drill hole for lotion dispenser	
Glossy, matt, special colour	

**Fittings information**

Impact area approx. 120 – 150 mm from middle tap hole.  
For parameters, see page 20.

<b>Recommended miscellaneous</b>	<b>Art. No.</b>
Bottle trap, Sl.2	8306 000 978
Bottle trap, Sl.3	8312 000 978
Angle valve cover, EV.3	8110 000 978

## Washstands – RE-series (X.plicit)

Mounting and connection measurements > see Page 202

### WT.RE1000H.R



Washstand, rectangular, w/h/d 1000/110/460 mm, sink rectangular, right, w/h/d 645/90/343 mm, glazed steel, with one tap hole, without overflow, included fixing set, drain valve, valve cap, white glazed, w/d 68/68 mm

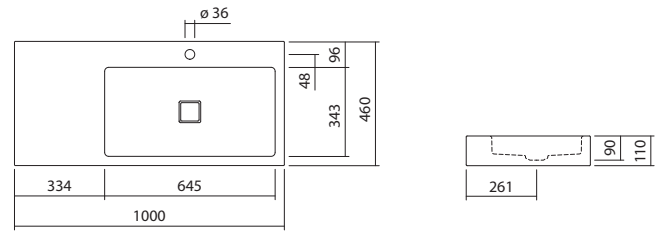

	Art. No.
white, ProShield	4104 000 000

Version
3 Drill holes
Drill hole for lotion dispenser
Glossy, matt, special colour

Fittings information
Impact area approx. 120 – 150 mm from middle tap hole.
For parameters, see page 20.

Recommended miscellaneous	Art. No.
Bottle trap, Sl.2	8306 000 978
Bottle trap, Sl.3	8312 000 978
Angle valve cover, EV.3	8110 000 978













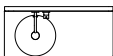

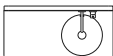
# Washplaces made from glazed steel

## **WP**

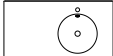

Xplore.S  
Washplace  
**WP . XS2**  
645 x 300 x 268mm

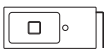
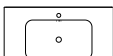

Width of washplace				
below 300mm	350 – 580mm	600 – 700mm	1000mm	
	 <p><b>WP.Insert1</b> 485 x 321mm Page 138</p>	 <p><b>WP.S19.1/.1R</b> 600 x 360mm Page 144</p>	 <p><b>WP.S19L.1/.1R</b> 1000 x 490mm Page 145</p>	<b>Round, wall-mounted</b>
	 <p><b>WP.Insert2</b> 485 x 321mm Page 138</p>		 <p><b>WP.S19L.2/.2R</b> 1000 x 490mm Page 146</p>	
	 <p><b>WP.Insert5</b> 355 x 350mm Page 139</p>		 <p><b>WP.WF20.1</b> 1000 x 525mm Page 147</p>	
	 <p><b>WP.PN1/SET.WP.PN1</b> 555 x 320 mm Page 140/141</p>		 <p><b>WP.WF20.2</b> 1000 x 525mm Page 147</p>	
	 <p><b>WP.PN2/SET.WP.PN2</b> 555 x 320 mm Page 140/141</p>		 <p><b>WP.WF20.3</b> 1000 x 525mm Page 148</p>	
			 <p><b>WP.WF20.4</b> 1000 x 525mm Page 148</p>	
	 <p><b>WP.XXS1</b> 580 x 236mm Page 142</p>	 <p><b>WP.XS1</b> 645 x 268mm Page 143</p>	 <p><b>WP.WF100.1</b> 1000 x 525mm Page 149</p>	<b>Rectangular</b>
	 <p><b>WP.XXS2</b> 580 x 236mm Page 142</p>	 <p><b>WP.XS2</b> 645 x 268mm Page 143</p>		

## Washplaces – Insert-series

Mounting and connection measurements > see Page 202

### WP . INSERT1



Washplace, rectangular, w/h/d 485/471/321 mm, dish basin, ProShield, sink left, with one tap hole, without overflow, shelf cabinet right, frame, chrome steel, powder finish, white, towel rail right, white, fixing set, drain valve, valve cap, chrome-plated, Ø 63 mm, bottle trap

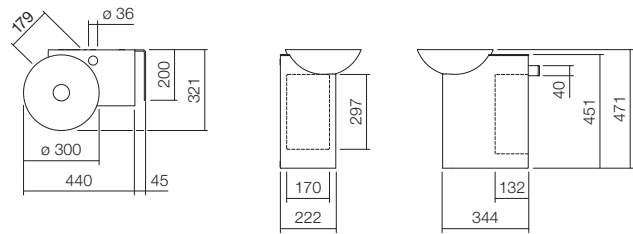

	Art. No.
white glazed steel shelf	5241 000 000
anthracite brown glazed steel shelf	5241 000 110

Recommended miscellaneous	Art. No.
Mirror, SP.300	6719 000 899

### Fittings information

Impact area approx. 109 – 139 mm from middle tap hole.  
For parameters, see page 20.

### WP . INSERT2



Washplace, rectangular, w/h/d 485/471/321 mm, dish basin, ProShield, sink right, with one tap hole, without overflow, shelf cabinet left, frame, chrome steel, powder finish, white, towel rail left, white, fixing set, drain valve, valve cap, chrome-plated, Ø 63 mm, bottle trap

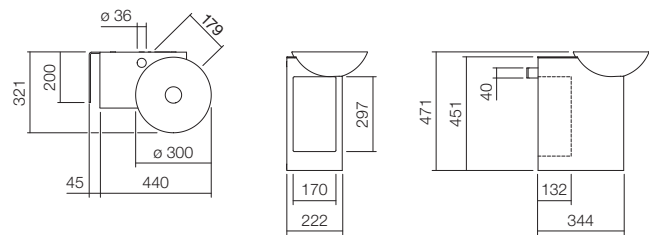

	Art. No.
white glazed steel shelf	5242 000 000
anthracite brown glazed steel shelf	5242 000 110

Recommended miscellaneous	Art. No.
Mirror, SP.300	6719 000 899

### Fittings information

Impact area approx. 109 – 139 mm from middle tap hole.  
For parameters, see page 20.

## Washplaces – Insert-series

Mounting and connection measurements > see Page 202

### WP . INSERT5

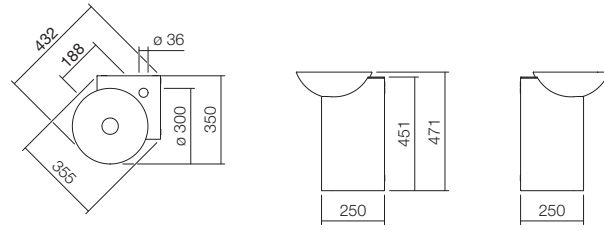

Corner washplace, rectangular, w/h/d 355/471/350 mm, dish basin, ProShield, sink centred, with one tap hole, without overflow, frame, chrome steel, powder finish, white, fixing set, drain valve, valve cap, chrome-plated, Ø 63 mm, bottle trap

	Art. No.
white glazed steel shelf	5245 000 000
anthracite brown glazed steel shelf	5245 000 110

Recommended miscellaneous	Art. No.
Corner mirror, SP.300C	6720 000 899

### Fittings information

Impact area approx. 117 – 147 mm from middle tap hole.  
For parameters, see page 20.

## Washplaces – PN-series (Piccolo Novo)

Mounting and connection measurements > see Page 202

### WP . PN1



Washplace, rectangular, w/h/d 555/400/320 mm, dish basin, sink left, Ø 300 mm, sink depth 112 mm, glazed steel, ProShield, with one tap hole, without overflow, steel, glazed, polished stainless steel, included fixing set, drain valve, valve cap, glazed in the basin colour, Ø 84 mm, chrome-plated bottle trap

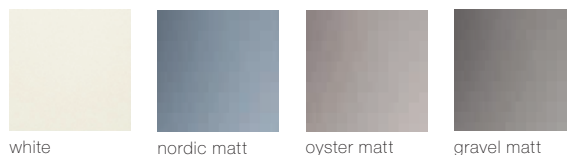
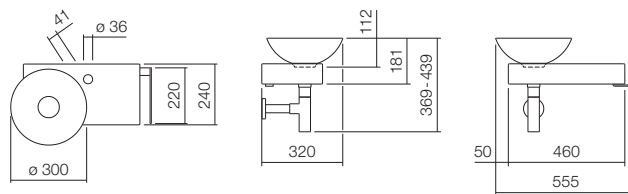

	Art. No.
white	5256 000 000
nordic matt	5256 000 083
oyster matt	5256 000 081
gravel matt	5256 000 084

Recommended miscellaneous	Art. No.
Mirror, SP.300	6719 000 899
Design mirror, SP.FR375.S1	6740 001 899

#### Fittings information

Impact area approx. 121 – 151 mm from middle tap hole.  
For parameters, see page 20.

### WP . PN2



Washplace, rectangular, w/h/d 555/400/320 mm, dish basin, sink right, Ø 300 mm, sink depth 112 mm, glazed steel, ProShield, with one tap hole, without overflow, steel, glazed, polished stainless steel, included fixing set, drain valve, valve cap, glazed in the basin colour, Ø 84 mm, chrome-plated bottle trap

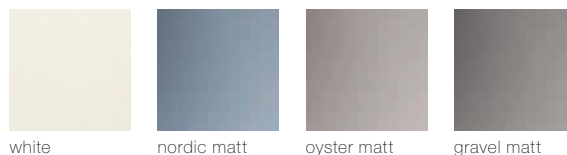
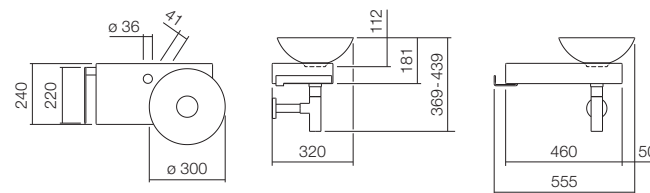

	Art. No.
white	5257 000 000
nordic matt	5257 000 083
oyster matt	5257 000 081
gravel matt	5257 000 084

Recommended miscellaneous	Art. No.
Mirror, SP.300	6719 000 899
Design mirror, SP.FR375.S1	6740 001 899

#### Fittings information

Impact area approx. 121 – 151 mm from middle tap hole.  
For parameters, see page 20.

## Washplaces – PN-series (Piccolo Novo)

Mounting and connection measurements > see Page 202

### SET . WP . PN1



Washplace, rectangular, w/h/d 555/597/320 mm, dish basin, sink left, Ø 300 mm, sink depth 112 mm, glazed steel, ProShield, with one tap hole, without overflow, steel, glazed, polished stainless steel, included fixing set, drain valve, valve cap, glazed in the basin colour, Ø 84 mm, chrome-plated bottle trap, single-lever basin mixer with raised base

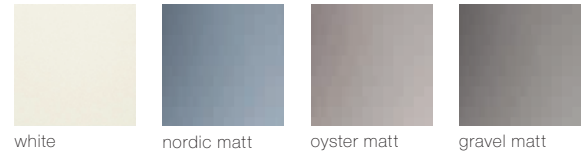
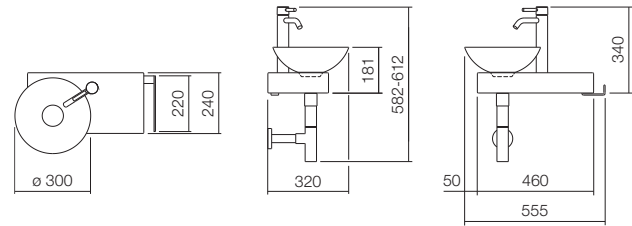

	Art. No.
white	0613 001 000
nordic matt	0613 001 083
oyster matt	0613 001 081
gravel matt	0613 001 084

Recommended miscellaneous	Art. No.
Mirror, SP.300	6719 000 899
Design mirror, SP.FR375.S1	6740 001 899

#### Fittings information

Impact area approx. 121 – 151 mm from middle tap hole.  
For parameters, see page 20.

### SET . WP . PN2



Washplace, rectangular, w/h/d 555/597/320 mm, dish basin, sink right, Ø 300 mm, sink depth 112 mm, glazed steel, ProShield, with one tap hole, without overflow, steel, glazed, polished stainless steel, included fixing set, drain valve, valve cap, glazed in the basin colour, Ø 84 mm, chrome-plated bottle trap, single-lever basin mixer with raised base

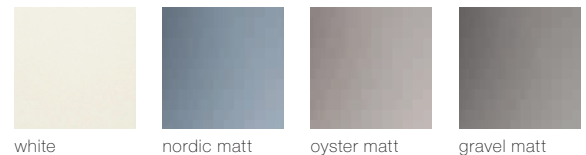
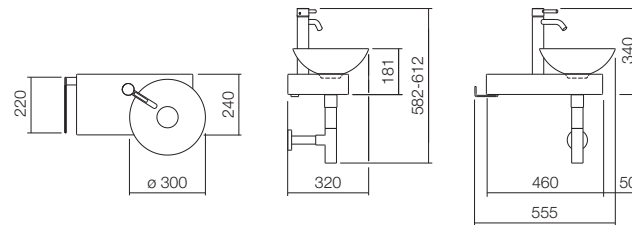

	Art. No.
white	0613 002 000
nordic matt	0613 002 083
oyster matt	0613 002 081
gravel matt	0613 002 084

Recommended miscellaneous	Art. No.
Mirror, SP.300	6719 000 899
Design mirror, SP.FR375.S1	6740 001 899

#### Fittings information

Impact area approx. 121 – 151 mm from middle tap hole.  
For parameters, see page 20.

**Washplaces – XXS-series (Fusion.S)**

Mounting and connection measurements &gt; see Page 203

**WP . XXS1**

Washplace, rectangular, w/h/d 580/240/236 mm, sink oval, left, glazed steel, with one tap hole, without overflow, shelf cabinet right, furniture surface, chipboard, decoration, glossy white, towel rail right, white, fixing set, drain valve, valve cap, chrome-plated, Ø 63 mm

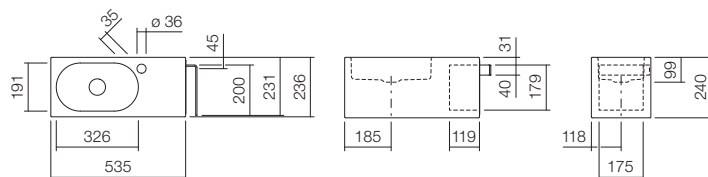

**Art. No.**  
white, ProShield 5062 800 000

**Recommended miscellaneous** **Art. No.**  
Mirror, SP.300 6719 000 899

**Fittings information**

Impact area approx. 70 – 145 mm from middle tap hole.  
For parameters, see page 20.

**WP . XXS2**

Washplace, rectangular, w/h/d 580/240/236 mm, sink oval, right, glazed steel, with one tap hole, without overflow, shelf cabinet left, furniture surface, chipboard, decoration, glossy white, towel rail left, white, fixing set, drain valve, valve cap, chrome-plated, Ø 63 mm

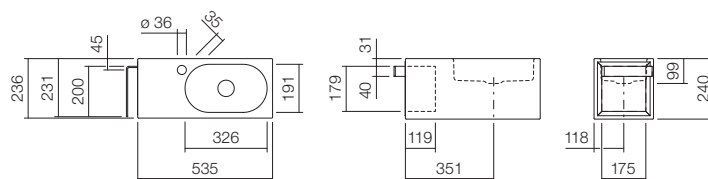

**Art. No.**  
white, ProShield 5065 800 000

**Recommended miscellaneous** **Art. No.**  
Mirror, SP.300 6719 000 899

**Fittings information**

Impact area approx. 70 – 145 mm from middle tap hole.  
For parameters, see page 20.

**Washplaces – XS-series (X.plore.S)**

Mounting and connection measurements > see Page 203

**WP . XS1**

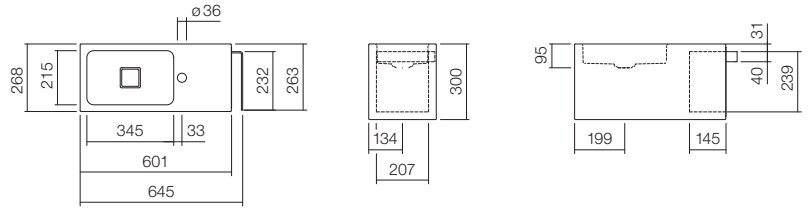

Washplace, rectangular, w/h/d 645/300/268 mm, sink rectangular, left, glazed steel, with one tap hole, without overflow, shelf cabinet right, furniture surface, chipboard, decoration, glossy white, towel rail right, white, fixing set, drain valve, valve cap, white glazed, w/d 68/68 mm

	<b>Art. No.</b>	<b>Recommended miscellaneous</b>	<b>Art. No.</b>
white, ProShield	5072 800 000	Mirror, SP.325	6716 000 899

**Fittings information**

Impact area approx. 110 – 205 mm from middle tap hole.  
For parameters, see page 20.

**WP . XS2**

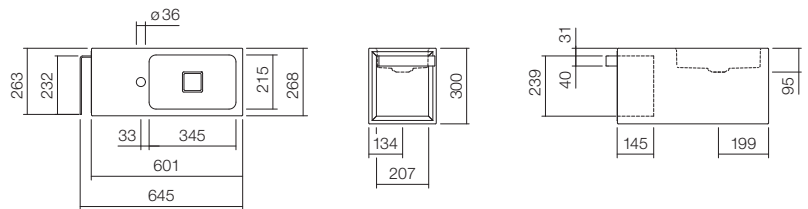

Washplace, rectangular, w/h/d 645/300/268 mm, sink rectangular, right, glazed steel, with one tap hole, without overflow, shelf cabinet left, furniture surface, chipboard, decoration, glossy white, towel rail left, white, fixing set, drain valve, valve cap, white glazed, w/d 68/68 mm

	<b>Art. No.</b>	<b>Recommended miscellaneous</b>	<b>Art. No.</b>
white, ProShield	5075 800 000	Mirror, SP.325	6716 000 899

**Fittings information**

Impact area approx. 110 – 205 mm from middle tap hole.  
For parameters, see page 20.

**Washplaces – S19-series (Steel19)**

Mounting and connection measurements &gt; see Page 204

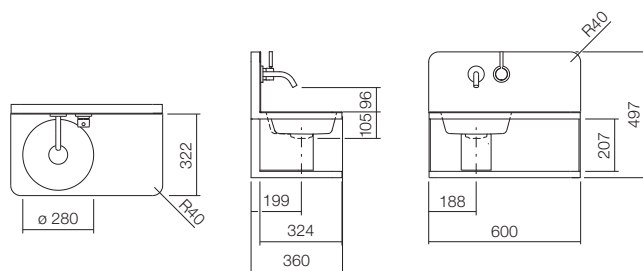
**WP . S19 . 1**

Washplace, rectangular, w/h/d 600/497/360 mm, sink round, left, glazed steel, without overflow, bracket, steel bracket, powder finish, black matte, fixing set, drain valve, valve cap, glazed in the basin colour, Ø 74 mm, bottle trap, bottle trap cover in matt black, glass shelf, wall outlet fitting in splashback, with pre-assembled concealed valve

	<b>Art. No.</b>
white, ProShield	5260 000 000

<b>Recommended miscellaneous</b>	<b>Art. No.</b>
Design mirror, SP.FR600.R1	6744 001 899
Shelf, AS.400.S	8270 000 980
Shelf, AS.600.S	8271 000 980
Perforated block, AS.Box1	8266 000 671
Box, AS.Box2	8267 000 671

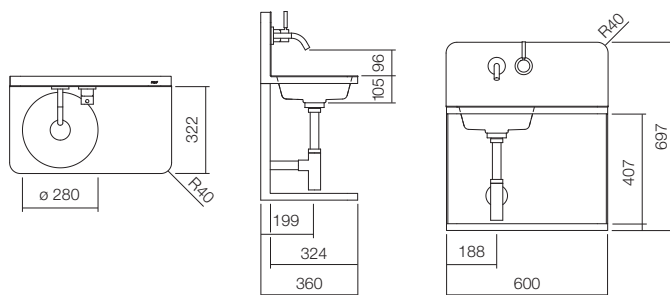
**WP . S19 . 1R**

Washplace for renovation, rectangular, w/h/d 600/697/360 mm, sink round, left, glazed steel, without overflow, bracket, steel bracket, powder finish, black matte, pressure hoses 600mm, fixing set, drain valve, valve cap, glazed in the basin colour, Ø 74 mm, bottle trap, glass shelf, wall outlet fitting in splashback, with pre-assembled concealed valve

	<b>Art. No.</b>
white, ProShield	5266 000 000

<b>Recommended miscellaneous</b>	<b>Art. No.</b>
Design mirror, SP.FR600.R1	6744 001 899
Shelf, AS.400.S	8270 000 980
Shelf, AS.600.S	8271 000 980
Perforated block, AS.Box1	8266 000 671
Box, AS.Box2	8267 000 671



## Washplaces – S19-series (Steel19)

Mounting and connection measurements > see Page 204

### WP . S19L . 1

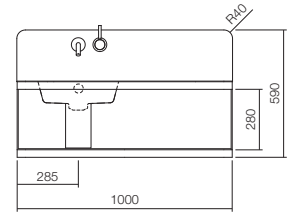
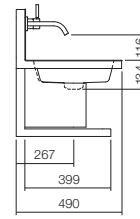
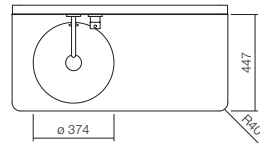

Washplace, rectangular, w/h/d 1000/590/490 mm, sink round, left, glazed steel, with overflow, bracket, steel bracket, powder finish, black matte, fixing set, valve cap, glazed in the basin colour,  $\varnothing$  74 mm, bottle trap, bottle trap cover in matt black, glass shelf, wall outlet fitting in splashback, with pre-assembled concealed valve

	Art. No.	Recommended miscellaneous	Art. No.
white, ProShield	5261 000 000	Design mirror, SP.FR600.R1	6744 001 899
		Shelf, AS.400.S	8270 000 980
		Shelf, AS.600.S	8271 000 980
		Shelf, AS.600.HT	8271 140 980
		Perforated block, AS.Box1	8266 000 671
		Box, AS.Box2	8267 000 671

### WP . S19L . 1R

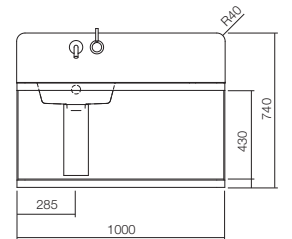
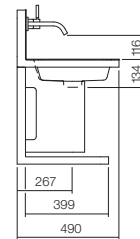
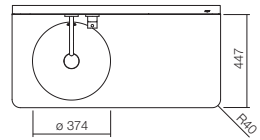

Washplace for renovation, rectangular, w/h/d 1000/740/490 mm, sink round, left, glazed steel, with overflow, bracket, steel bracket, powder finish, black matte, pressure hoses 600mm, fixing set, valve cap, glazed in the basin colour,  $\varnothing$  74 mm, bottle trap, bottle trap cover in matt black, glass shelf, wall outlet fitting in splashback, with pre-assembled concealed valve

	Art. No.	Recommended miscellaneous	Art. No.
white, ProShield	5267 000 000	Design mirror, SP.FR600.R1	6744 001 899
		Shelf, AS.400.S	8270 000 980
		Shelf, AS.600.S	8271 000 980
		Shelf, AS.600.HT	8271 140 980
		Perforated block, AS.Box1	8266 000 671
		Box, AS.Box2	8267 000 671

**Washplaces – S19-series (Steel19)**

Mounting and connection measurements &gt; see Page 204

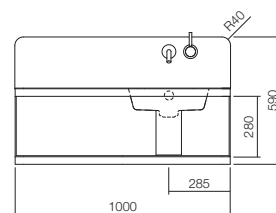
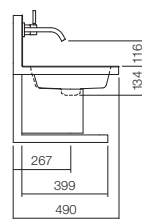
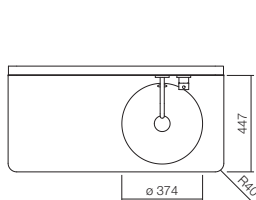
**WP . S19L . 2**

Washplace, rectangular, w/h/d 1000/590/490 mm, sink round, right, glazed steel, with overflow, bracket, steel bracket, powder finish, black matte, fixing set, valve cap, glazed in the basin colour, Ø 74 mm, bottle trap, bottle trap cover in matt black, glass shelf, wall outlet fitting in splashback, with pre-assembled concealed valve

**Art. No.**

white, ProShield

5262 000 000

**Recommended miscellaneous**

Design mirror, SP.FR600.R1  
Shelf, AS.400.S  
Shelf, AS.600.S  
Shelf, AS.600.HT  
Perforated block, AS.Box1  
Box, AS.Box2

**Art. No.**

6744 001 899  
8270 000 980  
8271 000 980  
8271 140 980  
8266 000 671  
8267 000 671

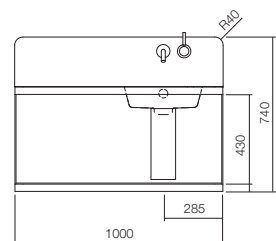
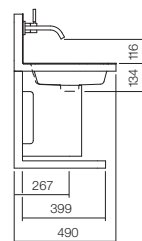
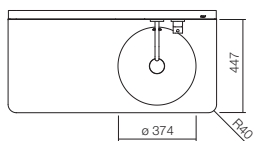
**WP . S19L . 2R**

Washplace for renovation, rectangular, w/h/d 1000/740/490 mm, sink round, right, glazed steel, with overflow, bracket, steel bracket, powder finish, black matte, pressure hoses 600mm, fixing set, valve cap, glazed in the basin colour, Ø 74 mm, bottle trap, bottle trap cover in matt black, glass shelf, wall outlet fitting in splashback, with pre-assembled concealed valve

**Art. No.**

white, ProShield

5268 000 000

**Recommended miscellaneous**

Design mirror, SP.FR600.R1  
Shelf, AS.400.S  
Shelf, AS.600.S  
Shelf, AS.600.HT  
Perforated block, AS.Box1  
Box, AS.Box2

**Art. No.**

6744 001 899  
8270 000 980  
8271 000 980  
8271 140 980  
8266 000 671  
8267 000 671

## Washplaces – WF-series (Work.Frame)

Mounting and connection measurements > see Page 205

### WP.WF20.1

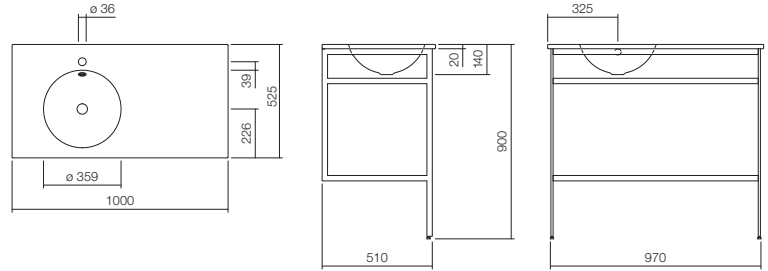

Washplace, rectangular, w/h/d 1000/900/525 mm, sink round, left, washstand cover 20mm, glazed steel, with one tap hole, with overflow, steel bracket, powder finish, black matte, fixing set, glass shelf, overflow set

#### Art. No.

white, ProShield

5271 000 000

#### Recommended miscellaneous

Bottle trap cover, SV.WF20.1.2  
 Bottle trap cover for renovation, SV.WF20.1.2R  
 Bottle trap, SI.3  
 Drain valve, VT.4  
 Drain valve, VT.5  
 Overflow rosette, UR.1  
 Design mirror, SP.FR375.S1  
 Shelf, AS.400.S

#### Art. No.

8113 000 980  
 8113 999 980  
 8312 000 978  
 8319 000 000  
 8320 000 000  
 8321 000 330  
 6740 001 899  
 8270 000 980

#### Fittings information

Impact area approx. 129 – 169 mm from middle tap hole.  
 For parameters, see page 20.

### WP.WF20.2

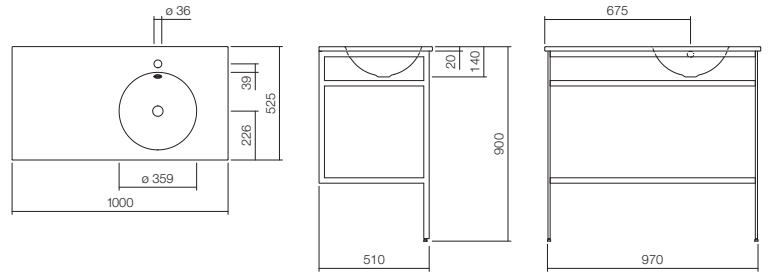

Washplace, rectangular, w/h/d 1000/900/525 mm, sink round, right, washstand cover 20mm, glazed steel, with one tap hole, with overflow, steel bracket, powder finish, black matte, fixing set, glass shelf, overflow set

#### Art. No.

white, ProShield

5272 000 000

#### Recommended miscellaneous

Bottle trap cover, SV.WF20.1.2  
 Bottle trap cover for renovation, SV.WF20.1.2R  
 Bottle trap, SI.3  
 Drain valve, VT.4  
 Drain valve, VT.5  
 Overflow rosette, UR.1  
 Design mirror, SP.FR375.S1  
 Shelf, AS.400.S

#### Art. No.

8113 000 980  
 8113 999 980  
 8312 000 978  
 8319 000 000  
 8320 000 000  
 8321 000 330  
 6740 001 899  
 8270 000 980

#### Fittings information

Impact area approx. 129 – 169 mm from middle tap hole.  
 For parameters, see page 20.

**Washplaces – WF-series (Work.Frame)**

Mounting and connection measurements &gt; see Page 205

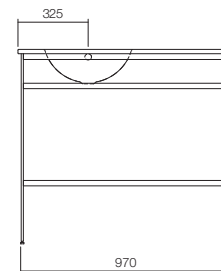
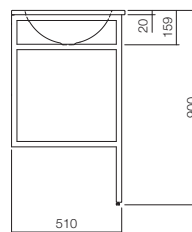
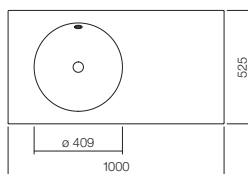
**WP . WF20 . 3**

Washplace, rectangular, w/h/d 1000/900/525 mm, sink round, left, washstand cover 20mm, glazed steel, without tap hole, with overflow, steel bracket, powder finish, black matte, fixing set, glass shelf, overflow set

	<b>Art. No.</b>
white, ProShield	5273 000 000

**Fittings information**

Impact area approx. 148 – 208 mm from rear edge of basin.  
For parameters, see page 20.

<b>Recommended miscellaneous</b>	<b>Art. No.</b>
Bottle trap cover, SV.WF20.3.4	8114 000 980
Bottle trap, Sl.3	8312 000 978
Drain valve, VT.4	8319 000 000
Drain valve, VT.5	8320 000 000
Overflow rosette, UR.1	8321 000 330
Design mirror, SP.FR375.S1	6740 001 899
Shelf, AS.400.S	8270 000 980
Perforated block, AS.Box1	8266 000 671

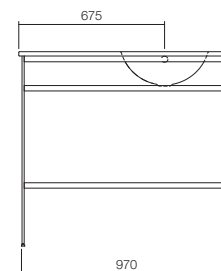
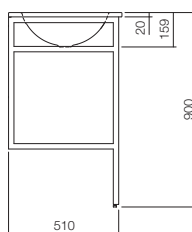
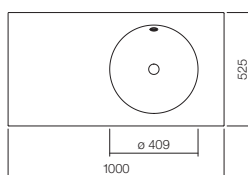
**WP . WF20 . 4**

Washplace, rectangular, w/h/d 1000/900/525 mm, sink round, right, washstand cover 20mm, glazed steel, without tap hole, with overflow, steel bracket, powder finish, black matte, fixing set, glass shelf, overflow set

	<b>Art. No.</b>
white, ProShield	5274 000 000

**Fittings information**

Impact area approx. 148 – 208 mm from rear edge of basin.  
For parameters, see page 20.

<b>Recommended miscellaneous</b>	<b>Art. No.</b>
Bottle trap cover, SV.WF20.3.4	8114 000 980
Bottle trap, Sl.3	8312 000 978
Drain valve, VT.4	8319 000 000
Drain valve, VT.5	8320 000 000
Overflow rosette, UR.1	8321 000 330
Design mirror, SP.FR375.S1	6740 001 899
Shelf, AS.400.S	8270 000 980
Perforated block, AS.Box1	8266 000 671

## Washplaces – WF-series (Work.Frame)

Mounting and connection measurements > see Page 205

### WP.WF100.1

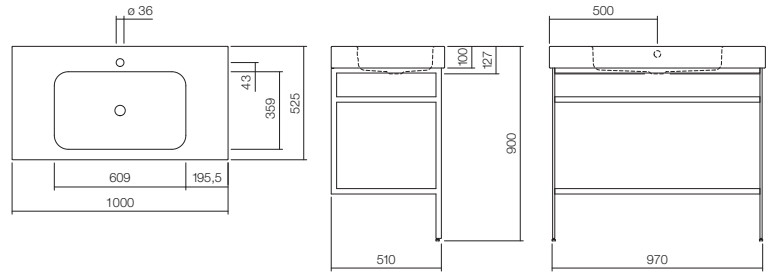

Washplace, rectangular, w/h/d 1000/900/525 mm, sink rectangular, centred, washstand cover 100mm, glazed steel, with one tap hole, with overflow, steel bracket, powder finish, black matte, fixing set, glass shelf, overflow set

	Art. No.
white, ProShield	5270 000 000

#### Fittings information

Impact area approx. 105 – 155 mm from middle tap hole.  
For parameters, see page 20.

Recommended miscellaneous	Art. No.
Bottle trap cover, SV.WF100.1	8112 000 980
Bottle trap cover for renovation, SV.WF100.1R	8112 999 980
Bottle trap, SI.3	8312 000 978
Drain valve, VT.4	8319 000 000
Drain valve, VT.5	8320 000 000
Overflow rosette, UR.1	8321 000 330
Design mirror, SP.FR750.R1	6745 001 899
Shelf, AS.400.S	8270 000 980

## Accessoires – WF-series (Work.Frame)

### SV.WF20.1.2



Bottle trap cover, w/h/d 118/440/355 mm, matt black, Powder coated, suitable for: WP.WF20.1, WP.WF20.2, angle valve distance 80mm maximum

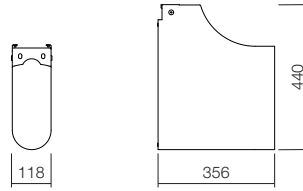

**Art. No.**

8113 000 980

### SV.WF20.1.2R



Bottle trap cover for renovation, w/h/d 118/440/355 mm, matt black, Powder coated, with side cutouts, suitable for: WP.WF20.1, WP.WF20.2, angle valve distance ;>80mm possible

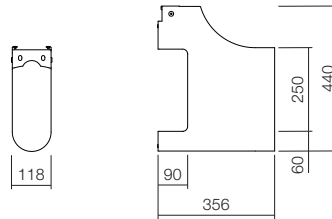

**Art. No.**

8113 999 980

### SV.WF20.3.4

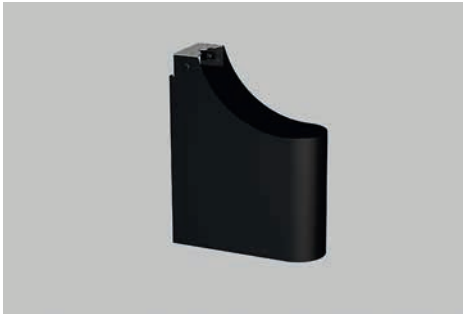

Bottle trap cover, w/h/d 118/440/319 mm, matt black, Powder coated, suitable for: WP.WF20.3, WP.WF20.4

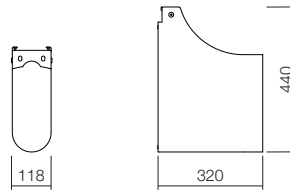

**Art. No.**

8114 000 980

### SV.WF100.1



Bottle trap cover, w/h/d 118/440/353 mm, matt black, Powder coated, suitable for: WP.WF100.1, angle valve distance 80mm maximum

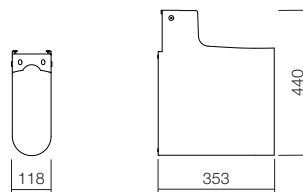

**Art. No.**

8112 000 980

**Accessoires – WF-series (Work.Frame)**

**SV.WF100.1R**



Bottle trap cover for renovation, w/h/d 118/440/353 mm, matt black, Powder coated, with side cutouts, suitable for: WP.WF100.1, angle valve distance ;>80mm possible

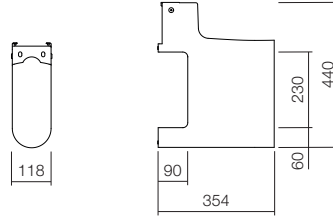

**Art. No.**

8112 999 980











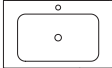

# Washplaces with floor cabinets

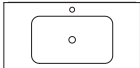
## WP

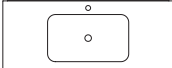

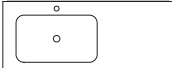
Folio  
Washplace  
**WP.Folio8**  
Moonstone  
1254 x 350 x 450mm

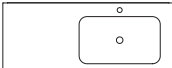

		Width of washplace				
	below 300mm	350 – 580mm	645 – 750mm	over 800mm		
	 <p><b>WP.Folio11</b> 381 x 363mm Page 154</p>					Round, wall-mounted
	 <p><b>WP.Folio12</b> 381 x 363mm Page 154</p>					
					 <p><b>WP.Folio1</b> 804 x 500mm Page 155</p>	Rectangular, wall-mounted
					 <p><b>WP.Folio2</b> 804 x 450mm Page 155</p>	
					 <p><b>WP.Folio3</b> 1004 x 500mm Page 156</p>	
					 <p><b>WP.Folio4</b> 1004 x 450mm Page 156</p>	
					 <p><b>WP.Folio5</b> 1254 x 500mm Page 157</p>	
					 <p><b>WP.Folio6</b> 1254 x 450mm Page 157</p>	
					 <p><b>WP.Folio7</b> 1254 x 500mm Page 158</p>	
					 <p><b>WP.Folio8</b> 1254 x 450mm Page 158</p>	
					 <p><b>WP.Folio9</b> 1254 x 500mm Page 159</p>	
					 <p><b>WP.Folio10</b> 1254 x 450mm Page 159</p>	

## Washplaces – FO-series (Folio)

Mounting and connection measurements > see Page 206

### WP.Folio11



Washplace, rectangular, w/h/d 381/361/363 mm, sink round, centred, Ø 272 mm, sink depth 82 mm, glazed steel, ProShield, with one tap hole, without overflow, washable cabinet, handle-free with push-to-open, door strike to the left, fixing set, drain valve, valve cap, white glazed, Ø 63 mm, space-saving bottle trap

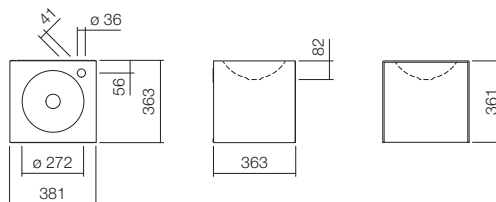

	Art. No.
wood effect laminate brushed oak	5161 816 000
silk-matt finish grey fossil	5161 810 000
silk-matt finish moonstone	5161 811 000
silk-matt finish shadow earth	5161 813 000
silk-matt finish white	5161 814 000

#### Fittings information

Impact area approx. 107 – 140 mm from middle tap hole.  
For parameters, see page 20.

Recommended miscellaneous	Art. No.
Design mirror, SP.FR375.S1	6740 001 899
Shelf, AS.400.S	8270 000 980
Shelf, AS.600.S	8271 000 980
Perforated block, AS.Box1	8266 000 671
Box, AS.Box2	8267 000 671

### WP.Folio12



Washplace, rectangular, w/h/d 381/361/363 mm, sink round, centred, Ø 272 mm, sink depth 82 mm, glazed steel, ProShield, without tap hole, without overflow, washable cabinet, handle-free with push-to-open, door strike to the left, fixing set, drain valve, valve cap, white glazed, Ø 63 mm, space-saving bottle trap

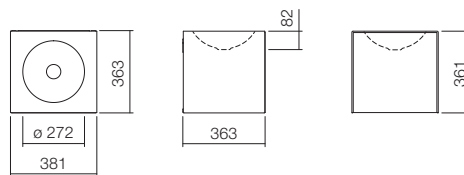

	Art. No.
wood effect laminate brushed oak	5161 516 000
silk-matt finish grey fossil	5161 510 000
silk-matt finish moonstone	5161 511 000
silk-matt finish shadow earth	5161 513 000
silk-matt finish white	5161 514 000

#### Fittings information

Impact area approx. 110 – 140 mm from rear edge of basin.  
For parameters, see page 20.

Recommended miscellaneous	Art. No.
Design mirror, SP.FR375.S1	6740 001 899
Shelf, AS.400.S	8270 000 980
Shelf, AS.600.S	8271 000 980
Perforated block, AS.Box1	8266 000 671
Box, AS.Box2	8267 000 671

**Washplaces – FO-series (Folio)**

Mounting and connection measurements > see Page 206

**WP.Folio1**

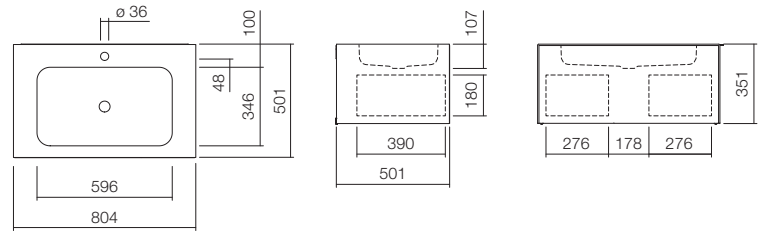

Washplace, rectangular, w/h/d 804/350/500 mm, sink rectangular, centred, w/h/d 596/107/346 mm, glazed steel, ProShield, with one tap hole, without overflow, washable cabinet, handle-free with push-to-open, full extension, fixing set, drain valve, valve cap, white glazed, Ø 74 mm, space-saving bottle trap



	<b>Art. No.</b>
wood effect laminate brushed oak	5155 816 000
silk-matt finish grey fossil	5155 810 000
silk-matt finish moonstone	5155 811 000
silk-matt finish shadow earth	5155 813 000
silk-matt finish white	5155 814 000

**Version**  
With overflow

**Fittings information**  
Impact area approx. 130 – 165 mm from middle tap hole.  
For parameters, see page 20.

<b>Recommended miscellaneous</b>	<b>Art. No.</b>
Tidying box, FU.BX1	8400 061 668
Shelf for cosmetics, FU.TB1	8400 063 669
Design mirror, SP.FR600.R1	6744 001 899
Shelf, AS.400.S	8270 000 980
Shelf, AS.600.S	8271 000 980
Perforated block, AS.Box1	8266 000 671
Drawer divider for internal drawer, FU.H358.2	8400 058 667

**WP.Folio2**

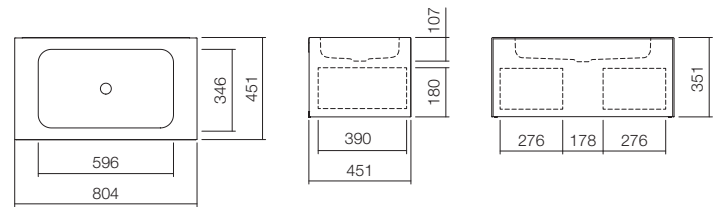

	<b>Art. No.</b>
wood effect laminate brushed oak	5155 516 000
silk-matt finish grey fossil	5155 510 000
silk-matt finish moonstone	5155 511 000
silk-matt finish shadow earth	5155 513 000
silk-matt finish white	5155 514 000

**Version**  
With overflow

**Fittings information**  
Impact area approx. 135 – 170 mm from rear edge of basin.  
For parameters, see page 20.

<b>Recommended miscellaneous</b>	<b>Art. No.</b>
Tidying box, FU.BX1	8400 061 668
Shelf for cosmetics, FU.TB1	8400 063 669
Design mirror, SP.FR600.R1	6744 001 899
Shelf, AS.400.S	8270 000 980
Shelf, AS.600.S	8271 000 980
Perforated block, AS.Box1	8266 000 671
Drawer divider for internal drawer, FU.H358.2	8400 058 667
Drawer divider for tidying box, FU.BX2	8400 062 668

**Washplaces – FO-series (Folio)**

Mounting and connection measurements > see Page 206

**WP.Folio3**

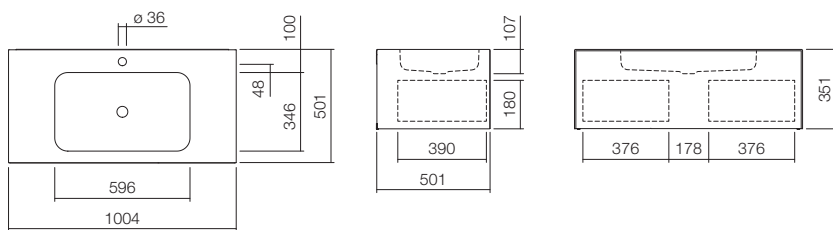

Washplace, rectangular, w/h/d 1004/350/500 mm, sink rectangular, centred, w/h/d 596/107/346 mm, glazed steel, ProShield, with one tap hole, without overflow, washable cabinet, handle-free with push-to-open, full extension, fixing set, drain valve, valve cap, white glazed, Ø 74 mm, space-saving bottle trap



	<b>Art. No.</b>
wood effect laminate brushed oak	5156 816 000
silk-matt finish grey fossil	5156 810 000
silk-matt finish moonstone	5156 811 000
silk-matt finish shadow earth	5156 813 000
silk-matt finish white	5156 814 000

**Version**  
With overflow

**Fittings information**  
Impact area approx. 130 – 165 mm from middle tap hole.  
For parameters, see page 20.

<b>Recommended miscellaneous</b>	<b>Art. No.</b>
Tidying box, FU.BX1	8400 061 668
Shelf for cosmetics, FU.TB1	8400 063 669
Design mirror, SP.FR600.R1	6744 001 899
Shelf, AS.400.S	8270 000 980
Shelf, AS.600.S	8271 000 980
Perforated block, AS.Box1	8266 000 671
Drawer divider for internal drawer, FU.H358.2	8400 058 667

**WP.Folio4**

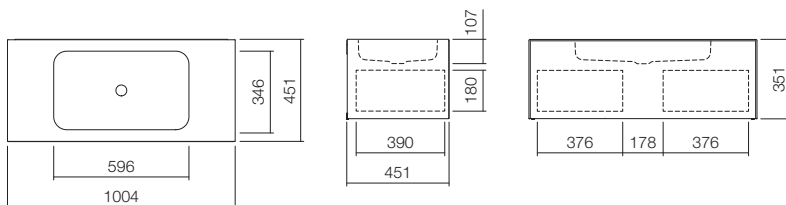

Washplace, rectangular, w/h/d 1004/350/450 mm, sink rectangular, centred, w/h/d 596/107/346 mm, glazed steel, ProShield, without tap hole, without overflow, washable cabinet, handle-free with push-to-open, full extension, fixing set, drain valve, valve cap, white glazed, Ø 74 mm, space-saving bottle trap

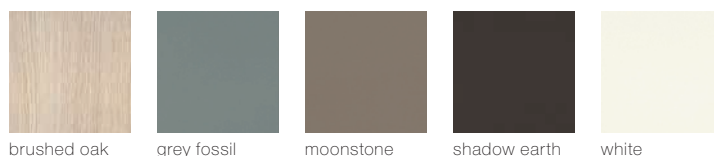

	<b>Art. No.</b>
wood effect laminate brushed oak	5156 516 000
silk-matt finish grey fossil	5156 510 000
silk-matt finish moonstone	5156 511 000
silk-matt finish shadow earth	5156 513 000
silk-matt finish white	5156 514 000

**Version**  
With overflow

**Fittings information**  
Impact area approx. 135 – 170 mm from rear edge of basin.  
For parameters, see page 20.

<b>Recommended miscellaneous</b>	<b>Art. No.</b>
Tidying box, FU.BX1	8400 061 668
Shelf for cosmetics, FU.TB1	8400 063 669
Design mirror, SP.FR600.R1	6744 001 899
Shelf, AS.400.S	8270 000 980
Shelf, AS.600.S	8271 000 980
Perforated block, AS.Box1	8266 000 671
Drawer divider for internal drawer, FU.H358.2	8400 058 667
Drawer divider for tidying box, FU.BX2	8400 062 668

## Washplaces – FO-series (Folio)

Mounting and connection measurements > see Page 206

### WP.Folio5

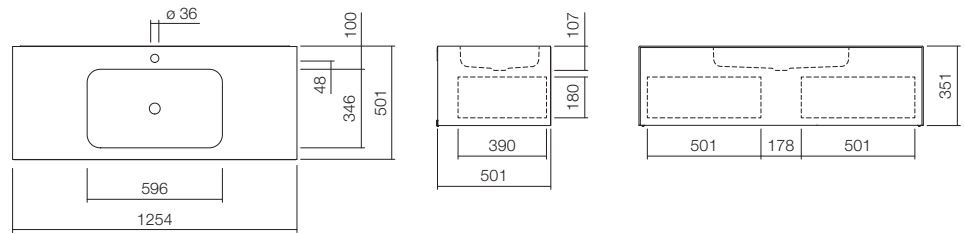

Washplace, rectangular, w/h/d 1254/350/500 mm, sink rectangular, centred, w/h/d 596/107/346 mm, glazed steel, ProShield, with one tap hole, without overflow, washable cabinet, handle-free with push-to-open, full extension, fixing set, drain valve, valve cap, white glazed, Ø 74 mm, space-saving bottle trap

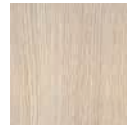

brushed oak



grey fossil



moonstone



shadow earth

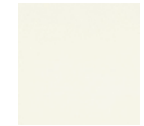

white

#### Art. No.

wood effect laminate brushed oak	5157 816 000
silk-matt finish grey fossil	5157 810 000
silk-matt finish moonstone	5157 811 000
silk-matt finish shadow earth	5157 813 000
silk-matt finish white	5157 814 000

#### Version

With overflow

#### Fittings information

Impact area approx. 130 – 165 mm from middle tap hole.  
For parameters, see page 20.

#### Recommended miscellaneous

	Art. No.
Tidying box, FU.BX1	8400 061 668
Shelf for cosmetics, FU.TB1	8400 063 669
Design mirror, SP.FR600.R1	6744 001 899
Shelf, AS.400.S	8270 000 980
Shelf, AS.600.S	8271 000 980
Perforated block, AS.Box1	8266 000 671
Drawer divider for internal drawer, FU.H358.2	8400 058 667

### WP.Folio6

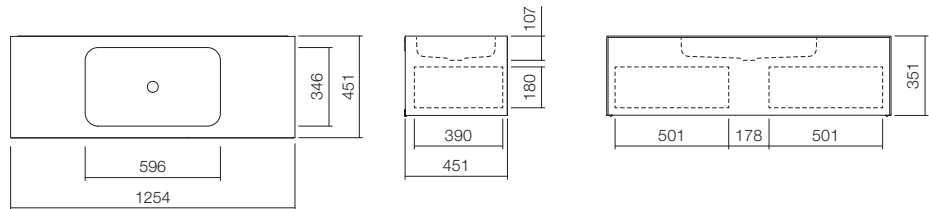

Washplace, rectangular, w/h/d 1254/350/450 mm, sink rectangular, centred, w/h/d 596/107/346 mm, glazed steel, ProShield, without tap hole, without overflow, washable cabinet, handle-free with push-to-open, full extension, fixing set, drain valve, valve cap, white glazed, Ø 74 mm, space-saving bottle trap

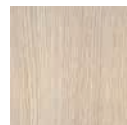

brushed oak



grey fossil



moonstone



shadow earth

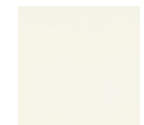

white

#### Art. No.

wood effect laminate brushed oak	5157 516 000
silk-matt finish grey fossil	5157 510 000
silk-matt finish moonstone	5157 511 000
silk-matt finish shadow earth	5157 513 000
silk-matt finish white	5157 514 000

#### Version

With overflow

#### Fittings information

Impact area approx. 135 – 170 mm from rear edge of basin.  
For parameters, see page 20.

#### Recommended miscellaneous

	Art. No.
Tidying box, FU.BX1	8400 061 668
Shelf for cosmetics, FU.TB1	8400 063 669
Design mirror, SP.FR600.R1	6744 001 899
Shelf, AS.400.S	8270 000 980
Shelf, AS.600.S	8271 000 980
Perforated block, AS.Box1	8266 000 671
Drawer divider for internal drawer, FU.H358.2	8400 058 667
Drawer divider for tidying box, FU.BX2	8400 062 668

**Washplaces – FO-series (Folio)**

Mounting and connection measurements &gt; see Page 207

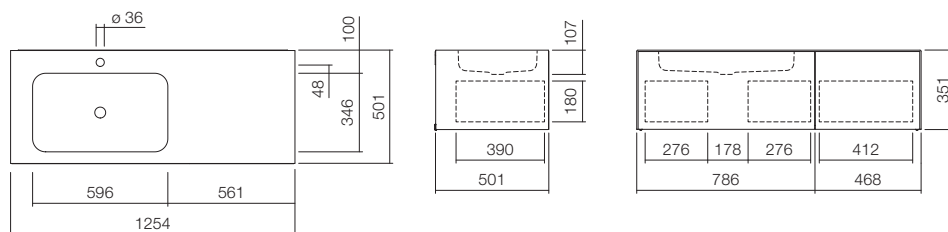
**WP.Folio7**

Washplace, rectangular, w/h/d 1254/350/500 mm, sink rectangular, left, w/h/d 596/107/346 mm, glazed steel, ProShield, with one tap hole, without overflow, washtable cabinet, handle-free with push-to-open, two full extensions, fixing set, drain valve, valve cap, white glazed, Ø 74 mm, space-saving bottle trap



brushed oak

grey fossil

moonstone

shadow earth

white

**Art. No.**

wood effect laminate brushed oak	5158 816 000
silk-matt finish grey fossil	5158 810 000
silk-matt finish moonstone	5158 811 000
silk-matt finish shadow earth	5158 813 000
silk-matt finish white	5158 814 000

**Version**

With overflow

**Fittings information**

Impact area approx. 130 – 165 mm from middle tap hole.  
For parameters, see page 20.

**Recommended miscellaneous****Art. No.**

Tidying box, FU.BX1	8400 061 668
Shelf for cosmetics, FU.TB1	8400 063 669
Design mirror, SP.FR600.R1	6744 001 899
Shelf, AS.400.S	8270 000 980
Shelf, AS.600.S	8271 000 980
Perforated block, AS.Box1	8266 000 671
Drawer divider for internal drawer, FU.H358.2	8400 058 667

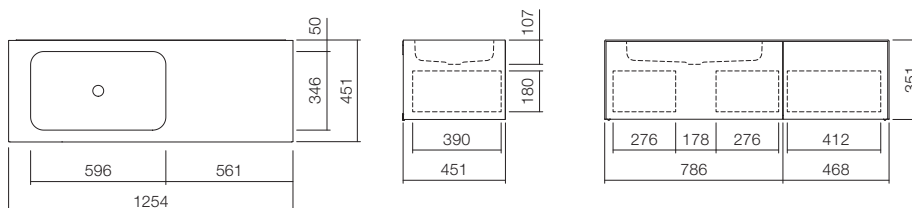
**WP.Folio8**

Washplace, rectangular, w/h/d 1254/350/450 mm, sink rectangular, left, w/h/d 596/107/346 mm, glazed steel, ProShield, without tap hole, without overflow, washtable cabinet, handle-free with push-to-open, two full extensions, fixing set, drain valve, valve cap, white glazed, Ø 74 mm, space-saving bottle trap



brushed oak

grey fossil

moonstone

shadow earth

white

**Art. No.**

wood effect laminate brushed oak	5158 516 000
silk-matt finish grey fossil	5158 510 000
silk-matt finish moonstone	5158 511 000
silk-matt finish shadow earth	5158 513 000
silk-matt finish white	5158 514 000

**Version**

With overflow

**Fittings information**

Impact area approx. 135 – 170 mm from rear edge of basin.  
For parameters, see page 20.

**Recommended miscellaneous****Art. No.**

Tidying box, FU.BX1	8400 061 668
Shelf for cosmetics, FU.TB1	8400 063 669
Design mirror, SP.FR600.R1	6744 001 899
Shelf, AS.400.S	8270 000 980
Shelf, AS.600.S	8271 000 980
Perforated block, AS.Box1	8266 000 671
Drawer divider for internal drawer, FU.H358.2	8400 058 667
Drawer divider for tidying box, FU.BX2	8400 062 668

**Washplaces – FO-series (Folio)**

Mounting and connection measurements > see Page 207

**WP.Folio9**

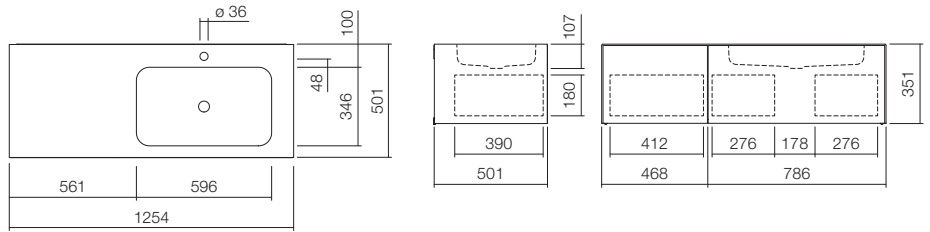

Washplace, rectangular, w/h/d 1254/350/500 mm, sink rectangular, right, w/h/d 596/107/346 mm, glazed steel, ProShield, with one tap hole, without overflow, washtable cabinet, handle-free with push-to-open, two full extensions, fixing set, drain valve, valve cap, white glazed, Ø 74 mm, space-saving bottle trap



	<b>Art. No.</b>
wood effect laminate brushed oak	5159 816 000
silk-matt finish grey fossil	5159 810 000
silk-matt finish moonstone	5159 811 000
silk-matt finish shadow earth	5159 813 000
silk-matt finish white	5159 814 000

**Version**  
With overflow

**Fittings information**  
Impact area approx. 130 – 165 mm from middle tap hole.  
For parameters, see page 20.

<b>Recommended miscellaneous</b>	<b>Art. No.</b>
Tidying box, FU.BX1	8400 061 668
Shelf for cosmetics, FU.TB1	8400 063 669
Design mirror, SP.FR600.R1	6744 001 899
Shelf, AS.400.S	8270 000 980
Shelf, AS.600.S	8271 000 980
Perforated block, AS.Box1	8266 000 671
Drawer divider for internal drawer, FU.H358.2	8400 058 667

**WP.Folio10**

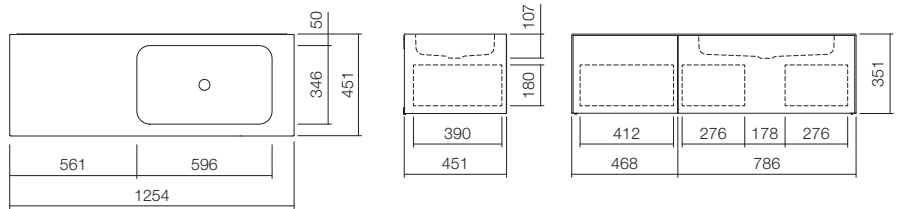

Washplace, rectangular, w/h/d 1254/350/450 mm, sink rectangular, right, w/h/d 596/107/346 mm, glazed steel, ProShield, without tap hole, without overflow, washtable cabinet, handle-free with push-to-open, two full extensions, fixing set, drain valve, valve cap, white glazed, Ø 74 mm, space-saving bottle trap



	<b>Art. No.</b>
wood effect laminate brushed oak	5159 516 000
silk-matt finish grey fossil	5159 510 000
silk-matt finish moonstone	5159 511 000
silk-matt finish shadow earth	5159 513 000
silk-matt finish white	5159 514 000

**Version**  
With overflow

**Fittings information**  
Impact area approx. 135 – 170 mm from rear edge of basin.  
For parameters, see page 20.

<b>Recommended miscellaneous</b>	<b>Art. No.</b>
Tidying box, FU.BX1	8400 061 668
Shelf for cosmetics, FU.TB1	8400 063 669
Design mirror, SP.FR600.R1	6744 001 899
Shelf, AS.400.S	8270 000 980
Shelf, AS.600.S	8271 000 980
Perforated block, AS.Box1	8266 000 671
Drawer divider for internal drawer, FU.H358.2	8400 058 667
Drawer divider for tidying box, FU.BX2	8400 062 668

## Accessories – FO-series (Folio)

### HS . F01250 . L



Cupboard, rectangular, w/h/d 300/1246/303 mm, one door, handle-free with push-to-open, door stop on the left, width with door open 355 mm (opening angle 105°), glazed side bracket on the right, white, included fixing set, 4 glass shelves, without dowels (to be adjusted to constructional situation)

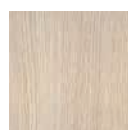
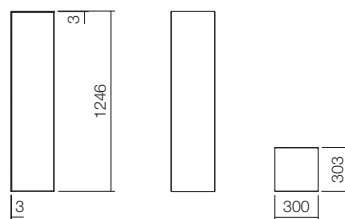

brushed oak



grey fossil



moonstone



shadow earth

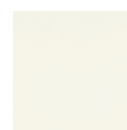

white

#### Art. No.

wood effect laminate brushed oak	6323 990 016
silk-matt finish grey fossil	6323 990 010
silk-matt finish moonstone	6323 990 011
silk-matt finish shadow earth	6323 990 013
silk-matt finish white	6323 990 014

### HS . F01250 . R



Cupboard, rectangular, w/h/d 300/1246/303 mm, one door, handle-free with push-to-open, door stop on the right, width with door open 355 mm (opening angle 105°), glazed side bracket on the left, white, included fixing set, 4 glass shelves, without dowels (to be adjusted to constructional situation)

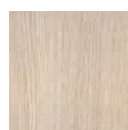
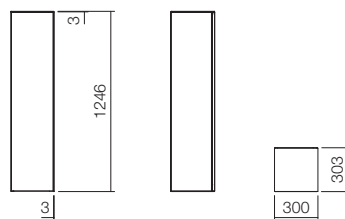

brushed oak



grey fossil



moonstone



shadow earth

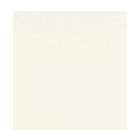

white

#### Art. No.

wood effect laminate brushed oak	6323 690 016
silk-matt finish grey fossil	6323 690 010
silk-matt finish moonstone	6323 690 011
silk-matt finish shadow earth	6323 690 013
silk-matt finish white	6323 690 014





Folio  
Waschplatz  
**WP.Folio8**  
Oak brushed  
1254 x 350 x 450 mm

**Accessories – FO-series (Folio)****FU . H358 . 1**

Drawer divider for internal drawer, rectangular, w/h/d 154/69/357 mm, metallic black, Structured finish

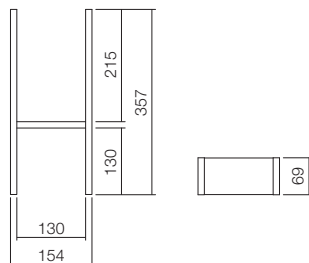
**Art. No.**

8400 057 667

**FU . H408 . 1**

Drawer divider for internal drawer, rectangular, w/h/d 154/69/407 mm, metallic black, Structured finish

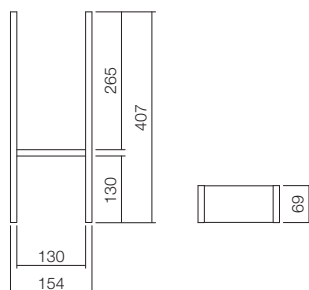
**Art. No.**

8400 059 667

**FU . H358 . 2**

Drawer divider for internal drawer, rectangular, w/h/d 154/69/357 mm, metallic black, Structured finish

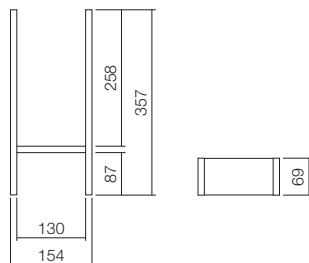
**Art. No.**

8400 058 667

**FU . TI1**

Tissue box, rectangular, w/h/d 129/68/257 mm, anthracite black, Powder coated

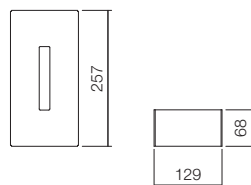
**Art. No.**

8400 060 668

## Accessories – FO-series (Folio)

### FU . BX1



Tidying box, rectangular, w/h/d 129/68/257 mm, anthracite black, Powder coated, base with felt cushions

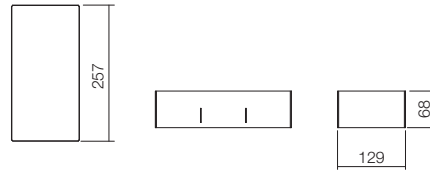

**Art. No.**

8400 061 668

### FU . BX2

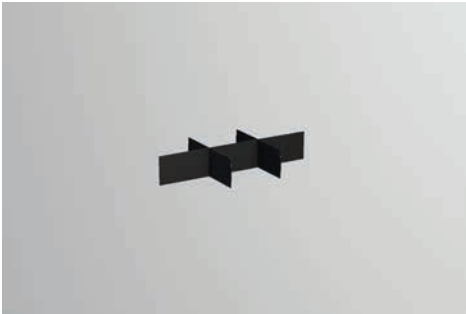

Drawer divider for tidying box, rectangular, w/h/d 126/45/254 mm, anthracite black, Powder coated

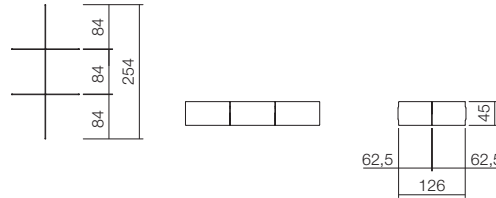

**Art. No.**

8400 062 668

### FU . TB1



Shelf for cosmetics, rectangular, w/h/d 129/24/257 mm, solid oak, Whitewashed



**Art. No.**

8400 063 669

# Bucket sinks

## **AG**



Bucket sink  
**AG . STAHLFORM510Ü**  
510 x 365 x 330mm

# Bucket sinks

The multi-purpose basin for basements, garages, workshops, gardens and lofts. With coloured edge protection and high-drawn, integrated back splash. The Alape original from the fifties. Proven a thousand times over through robustness and quality.

**Bucket sinks – AG-series****AG.Stahlform 510Ü**

Bucket sink, rectangular, w/h/d 510/365/330 mm, without tap hole, with overflow, PVC edge, black, drain and overflow fitting with chain and plug, Minimum order quantity 1 pallet (24 pc)

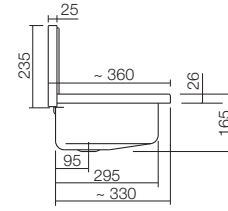
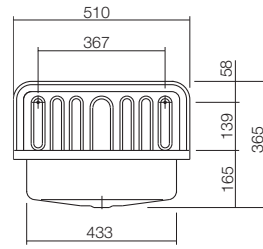
**Art. No.**

white

1200 000 000

**AG.Stahlform 510Ü**

Bucket sink, rectangular, w/h/d 510/365/330 mm, without tap hole, with overflow, PVC edge, black, bottle trap, drain and overflow fitting with chain and plug

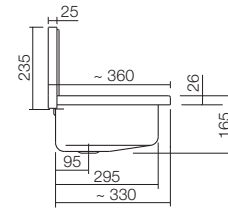
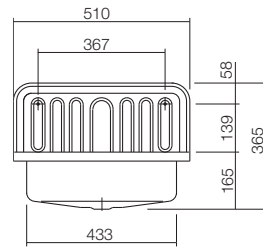
**Art. No.**

matt black/glossy white white

1205 000 180

**UTENSILO**

Shelf, w/h/d 517/558/270 mm, Powder coated, steel shelf suitable for Alape AG.STAHLFORM510Ü bucket sinks

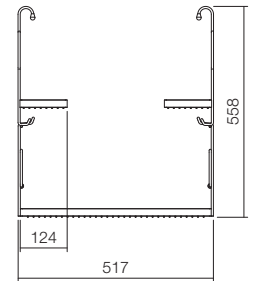
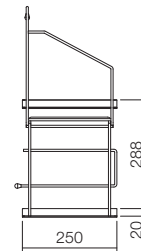
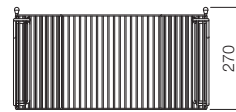
**Art. No.**

matt black

8902 000 980

**AG.Stahlform 505**

Bucket sink, rectangular, w/h/d 505/360/330 mm, without tap hole, without overflow, PVC edge, black, drain valve with chain and plug, without Aluminium grid, Minimum order quantity 1 pallet (24 pc)

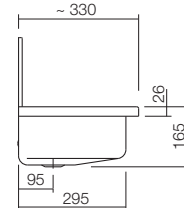
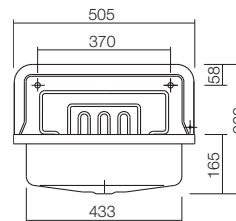
**Art. No.**

white

1100 000 000

## Bucket sinks – AG-series

### Aluminium grid



Aluminium grid, w/h/d 520/55/285 mm, aluminium, natural

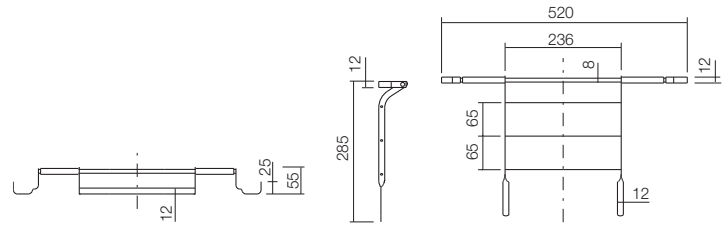

**Art. No.**

Aluminium

8901 000 722

### AG.CONTRA505



Bucket sink, rectangular, w/h/d 505/360/330 mm, without tap hole, without overflow, PVC edge, grey, drain valve with chain and plug, Minimum order quantity 1 pallet (24 pc)

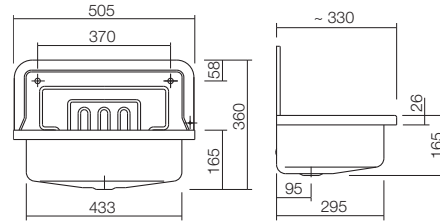

**Art. No.**

white

1300 000 000

# Shelf system – Assist

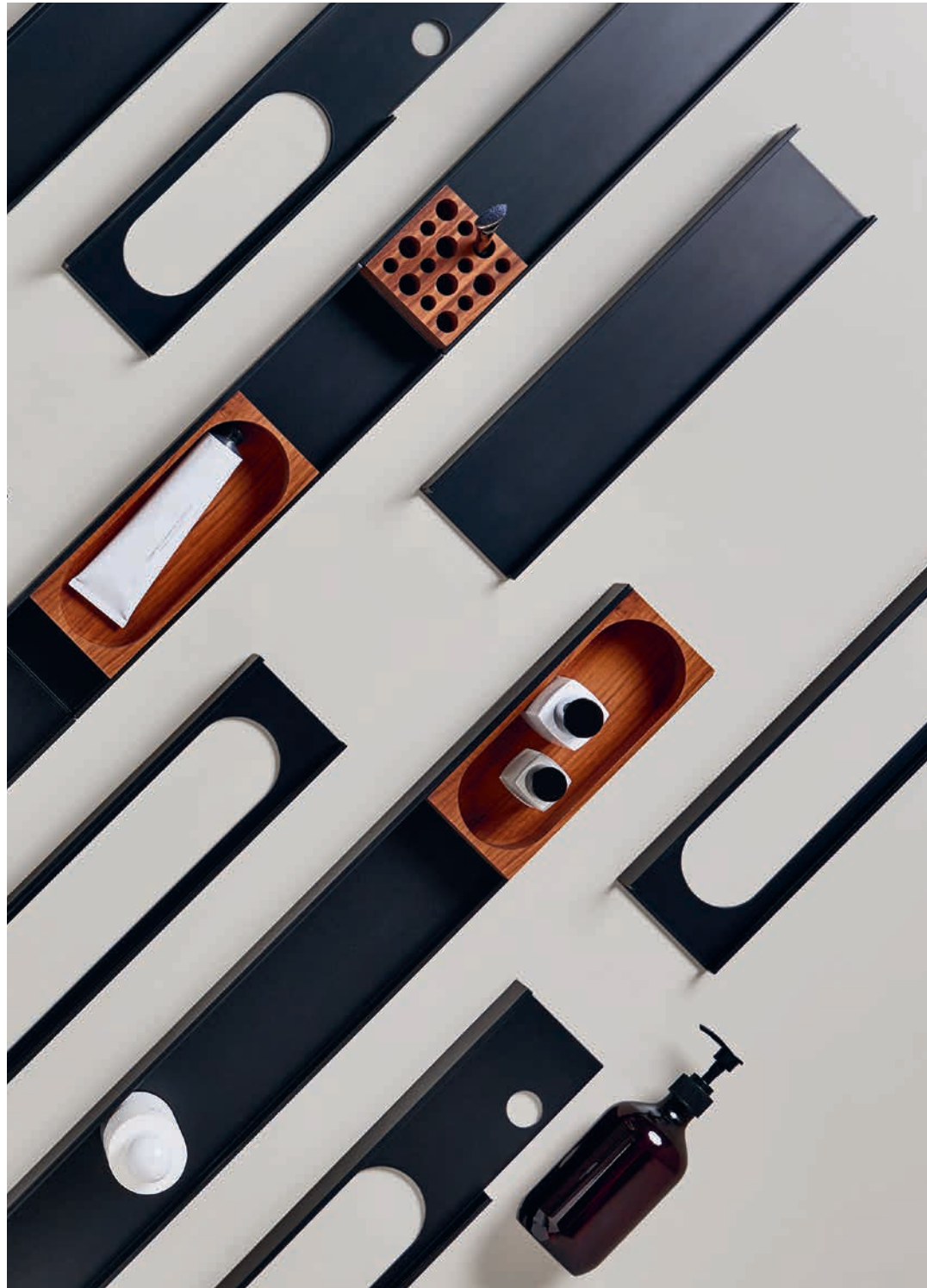



Width — Shelves

Assist — Shelves

400mm

**AS . 400 . S**  
400 x 50 x 100mm  
Page 170

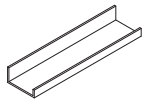

600mm

**AS . 600 . S**  
600 x 50 x 100mm  
Page 170

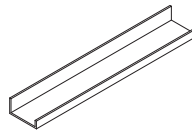

800mm

**AS . 800 . S**  
800 x 50 x 100mm  
Page 170

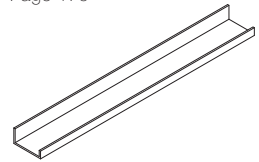

**AS . 400 . HT . L/R**  
400 x 196 x 111  
Page 171

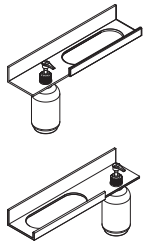

**AS . 600 . HT**  
600 x 50 x 100mm  
Page 170

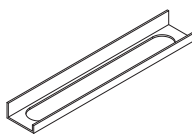

Assist — Accessories

**AS . Box1**  
89 x 44 x 89mm  
Page 171



**AS . Box2**  
225 x 44 x 89mm  
Page 171



**AS . 160 . TPH**  
160 x 50 x 100mm  
Page 172



Assist — Shower shelves

**AS . 400 . S**  
400 x 50 x 100mm  
Page 172

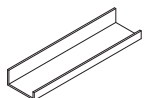

**AS . 134 . L02**  
134 x 50 x 85mm  
Page 172



**AS . 225 . L03**  
225 x 50 x 85mm  
Page 172



**Assist – Shelves****AS. 400.S**

Shelf, rectangular, w/h/d 400/50/100 mm, aluminium, Powder coated, without cutouts, included fixing set, without dowels (to be adjusted to constructional situation)



matt black  
matt white

**Art. No.**

8270 000 980  
8270 000 331

**AS. 600.S**

Shelf, rectangular, w/h/d 600/50/100 mm, aluminium, Powder coated, without cutouts, included fixing set, without dowels (to be adjusted to constructional situation)

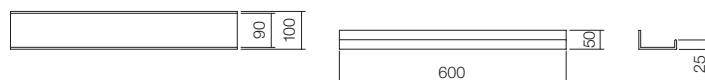

matt black  
matt white

**Art. No.**

8271 000 980  
8271 000 331

**AS. 800.S**

Shelf, rectangular, w/h/d 800/50/100 mm, aluminium, Powder coated, without cutouts, included fixing set, without dowels (to be adjusted to constructional situation)



matt black  
matt white

**Art. No.**

8272 000 980  
8272 000 331

**AS. 600.HT**

Shelf, rectangular, w/h/d 600/50/100 mm, aluminium, Powder coated, towel cutout central, included fixing set, without dowels (to be adjusted to constructional situation)



matt black  
matt white

**Art. No.**

8271 140 980  
8271 140 331

**Assist – Shelves**

**AS . 400 . HT . L**



Shelf, rectangular, w/h/d 400/196/111 mm, aluminium, Powder coated, lotion dispenser cutout right, towel cutout left, included fixing set, plastic bottle, without dowels (to be adjusted to constructional situation)

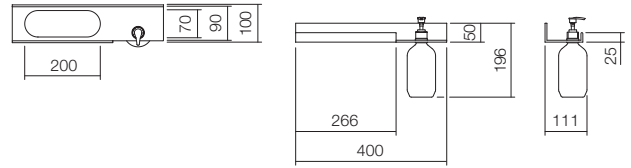

matt black  
matt white

**Art. No.**

8270 221 980  
8270 221 331

**AS . 400 . HT . R**



Shelf, rectangular, w/h/d 400/196/111 mm, aluminium, Powder coated, lotion dispenser cutout left, towel cutout, right, included fixing set, plastic bottle, without dowels (to be adjusted to constructional situation)

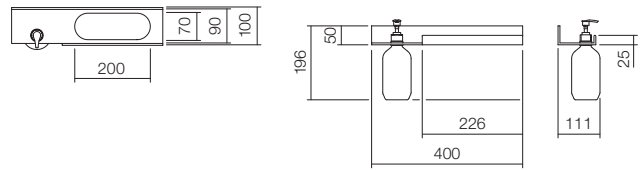

matt black  
matt white

**Art. No.**

8270 321 980  
8270 321 331

**AS . Box1**



Perforated block, rectangular, w/h/d 89/44/89 mm, american walnut, Oiled, with 16 drill holes, 12 and 17 mm diameter

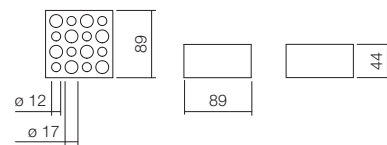

**Art. No.**

8266 000 671

**AS . Box2**



Box, rectangular, w/h/d 225/44/89 mm, american walnut, Oiled, with oval cutout, approx. width: 215 mm

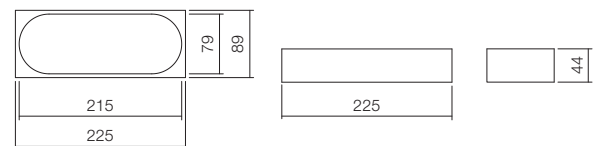

**Art. No.**

8267 000 671

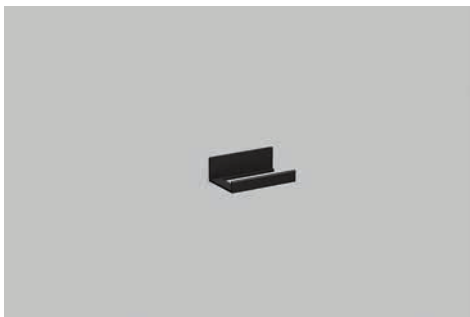
**Assist – Shelves, Shower shelves****AS.160.TPH**

Toiletry, rectangular, w/h/d 160/50/100 mm, aluminium, Powder coated, included fixing set, without dowels (to be adjusted to constructional situation)

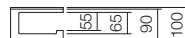

matt black  
matt white

**Art. No.**

8274 170 981  
8274 170 982

**AS.400.S**

Shower shelf, rectangular, w/h/d 400/50/100 mm, aluminium, Powder coated, without cutouts, included fixing set, without dowels (to be adjusted to constructional situation)

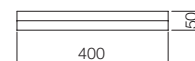

matt black  
matt white

**Art. No.**

8270 000 981  
8270 000 982

**AS.134.L02**

Shower shelf, rectangular, w/h/d 134/50/85 mm, aluminium, Powder coated, two lotion dispenser cutouts, included fixing set, two plastic bottles, without dowels (to be adjusted to constructional situation)

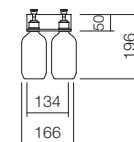

matt black  
matt white

**Art. No.**

8274 111 981  
8274 111 982

**AS.225.L03**

Shower shelf, rectangular, w/h/d 225/50/85 mm, aluminium, Powder coated, three lotion dispenser cutouts, included fixing set, three plastic bottles, without dowels (to be adjusted to constructional situation)

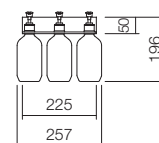

matt black  
matt white

**Art. No.**

8274 112 981  
8274 112 982









Assist  
Shower shelves  
**AS.400.S**  
**AS.225.L03**

# Design mirrors



Mirror  
**SP.FR375.S1**  
375 x 800 x 40mm

Unisono  
Washstand Bicolor  
**WT.RX400.KE**  
400 x 900 x 442mm

Width			
375-450 mm	500-750 mm	1000 mm	
	 <p><b>SP.FR600.R1</b> ø 600 x 40mm Page 178</p>	 <p><b>SP.FR1000.R1</b> ø 1000 x 40mm Page 178</p>	<b>Round</b>
	 <p><b>SP.FR750.R1</b> ø 750 x 40mm Page 178</p>		
 <p><b>SP.FR375.S1</b> 375 x 800 x 40mm Page 176</p>	 <p><b>SP.FR500.S1</b> 500 x 1000 x 40mm Page 176</p>		<b>Rectangular</b>
 <p><b>SP.FR450.S1</b> 450 x 800 x 40mm Page 176</p>	 <p><b>SP.FR600.S1</b> 600 x 1000 x 40mm Page 177</p>		

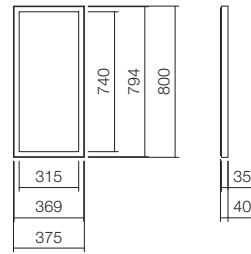
**Design mirrors – rectangular**Mounting and connection measurements: Download [www.alape.com](http://www.alape.com)**SP . FR375 . S1**

Design mirror, rectangular, w/h/d 375/800/40 mm, aluminium, Powder coated, indirect circumferential LED light, dimmable, 11.7 watts, luminous colour: 4,000 Kelvin, included fixing set, LED converter, touch switch and auxiliary function, without dowels (to be adjusted to constructional situation)

**Art. No.**

matt black  
matt white

6740 001 899  
6740 001 331

**Technical information**

Protection class IP44, Safety class 1

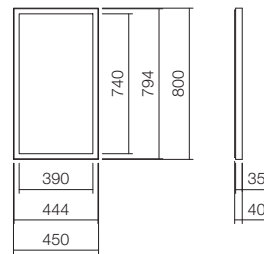
**SP . FR450 . S1**

Design mirror, rectangular, w/h/d 450/800/40 mm, aluminium, Powder coated, indirect circumferential LED light, dimmable, 12.6 watts, luminous colour: 4,000 Kelvin, included fixing set, LED converter, touch switch and auxiliary function, without dowels (to be adjusted to constructional situation)

**Art. No.**

matt black  
matt white

6741 001 899  
6741 001 331

**Technical information**

Protection class IP44, Safety class 1

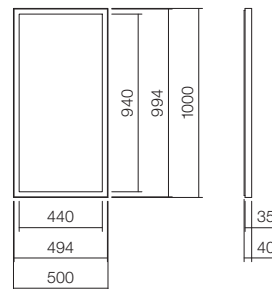
**SP . FR500 . S1**

Design mirror, rectangular, w/h/d 500/1000/40 mm, aluminium, Powder coated, indirect circumferential LED light, dimmable, 14 watts, luminous colour: 4,000 Kelvin, included fixing set, LED converter, touch switch and auxiliary function, without dowels (to be adjusted to constructional situation)

**Art. No.**

matt black  
matt white

6742 001 899  
6742 001 331

**Technical information**

Protection class IP44, Safety class 1



## Design mirrors – rectangular

Mounting and connection measurements: Download [www.alape.com](http://www.alape.com)

### SP . FR600 . S1

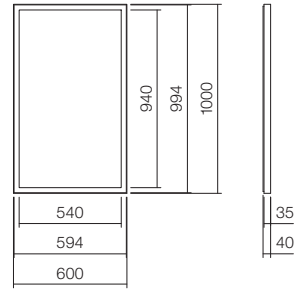

Design mirror, rectangular, w/h/d 600/1000/40 mm, aluminium, Powder coated, indirect circumferential LED light, dimmable, 15 watts, luminous colour: 4,000 Kelvin, included fixing set, LED converter, touch switch and auxiliary function, without dowels (to be adjusted to constructional situation)

#### Art. No.

matt black  
matt white

6743 001 899  
6743 001 331

#### Technical information

Protection class IP44, Safety class 1

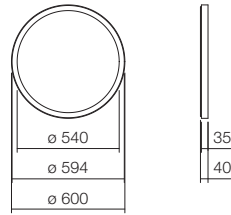
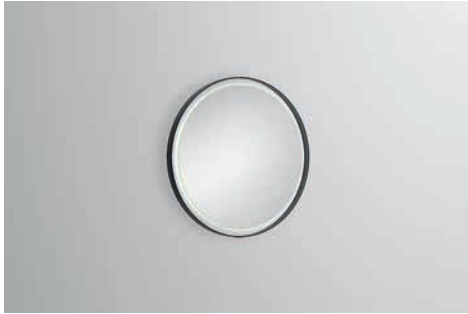
**Design mirrors – round**Mounting and connection measurements: Download [www.alape.com](http://www.alape.com)**SP . FR600 . R1**

Design mirror, round, w/h/d 600/600/40 mm, aluminium, Powder coated, indirect circumferential LED light, dimmable, 9.3 watts, luminous colour: 4,000 Kelvin, included fixing set, LED converter, touch switch and auxiliary function, without dowels (to be adjusted to constructional situation)

**Art. No.**

matt black  
matt white

6744 001 899  
6744 001 331

**Technical information**

Protection class IP44, Safety class 1

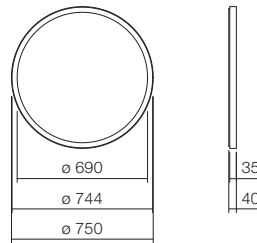
**SP . FR750 . R1**

Design mirror, round, w/h/d 750/750/40 mm, aluminium, Powder coated, indirect circumferential LED light, dimmable, 12.3 watts, luminous colour: 4,000 Kelvin, included fixing set, LED converter, touch switch and auxiliary function, without dowels (to be adjusted to constructional situation)

**Art. No.**

matt black  
matt white

6745 001 899  
6745 001 331

**Technical information**

Protection class IP44, Safety class 1

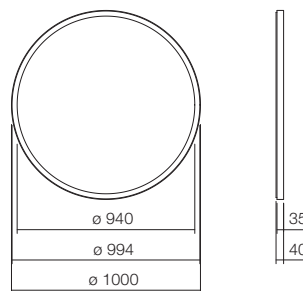
**SP . FR1000 . R1**

Design mirror, round, w/h/d 1000/1000/40 mm, aluminium, Powder coated, indirect circumferential LED light, dimmable, 15 watts, luminous colour: 4,000 Kelvin, included fixing set, LED converter, touch switch and auxiliary function, without dowels (to be adjusted to constructional situation)

**Art. No.**

matt black  
matt white

6746 001 899  
6746 001 331

**Technical information**

Protection class IP44, Safety class 1



Design mirror  
**SP.FR750.R1**  
ø 750 x 40mm

Folio  
Washplace  
**WP.Folio7**  
1250 x 350 x 500mm

# Mirrors and Lighting



Mirror  
**SP. 300C**  
324 x 800 x 66mm

Insert  
Washplace  
**WP.Insert.5**  
355 x 471 x 350mm

# Lights

## LE . 2

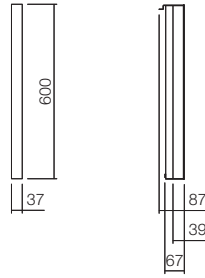
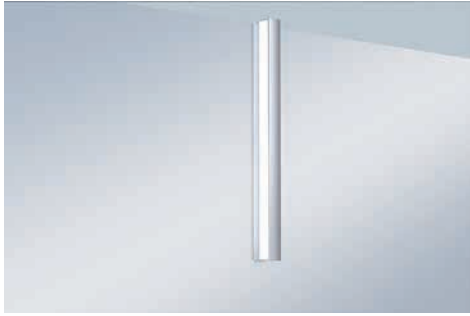

Light, rectangular, w/h/d 37/600/67 mm, front screen with mirror-finish, dimmable 10 watt LED lights, luminous colour: 4,100 Kelvin, included LED converter, combinable with ALAPE SP mirror

w/h/d 37/600/67 mm

**Art. No.**

8011 001 978

## LE . 3

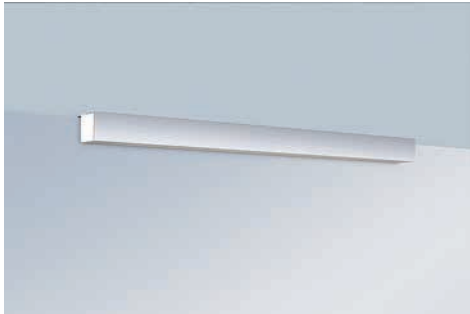

Light, rectangular, w/h/d 600/38/39 mm, front screen with mirror-finish, dimmable 10 watt LED lights, luminous colour: 4,100 Kelvin, included LED converter, combinable with ALAPE SP mirror

w/h/d 600/38/39 mm

**Art. No.**

8012 001 978

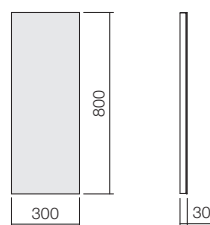
**Mirrors****SP . 300**

Mirror, rectangular, w/h/d 300/800/30 mm, white powder coated side profiles, included fixing set

**Art. No.**

w/h/d 300/800/30 mm

6719 000 899

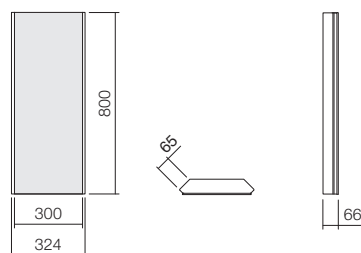
**SP . 300C**

Corner mirror, rectangular, w/h/d 324/800/66 mm, white powder coated side profiles, included fixing set

**Art. No.**

w/h/d 324/800/66 mm

6720 000 899

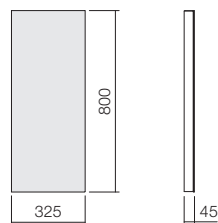
**SP . 325**

Mirror, rectangular, w/h/d 325/800/45 mm, aluminium frame, included fixing set

**Art. No.**

w/h/d 325/800/45 mm

6716 000 899

**Mirrors**

Mounting and connection measurements &gt; see Page193

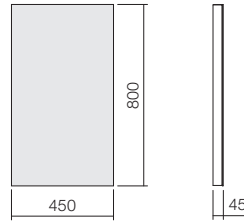
**SP . 450**

Mirror, rectangular, w/h/d 450/800/45 mm, aluminium frame, included fixing set

**Art. No.**

w/h/d 450/800/45 mm

6717 000 899

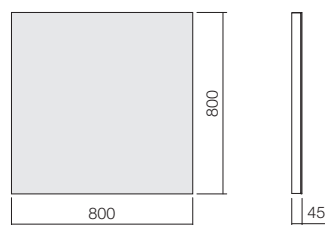
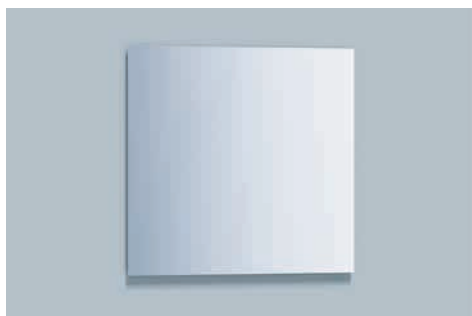
**Mirrors****SP.2 - 800 mm**

Mirror, rectangular, w/h/d 800/800/45 mm, aluminium frame, included fixing set, rail system for optional accommodation of lamp LE.2/ LE.3

**Art. No.**

w/h/d 800/800/45 mm

6736 000 899

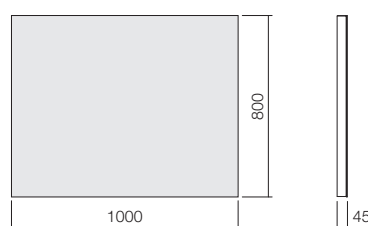
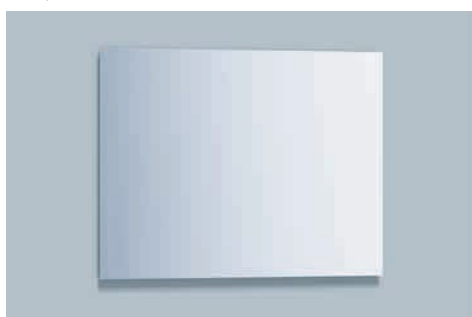
**SP.2 - 1000 mm**

Mirror, rectangular, w/h/d 1000/800/45 mm, aluminium frame, included fixing set, rail system for optional accommodation of lamp LE.2/ LE.3

**Art. No.**

w/h/d 1000/800/45 mm

6736 001 899

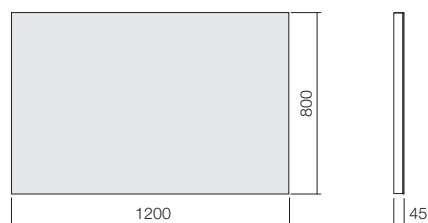
**SP.2 - 1200 mm**

Mirror, rectangular, w/h/d 1200/800/45 mm, aluminium frame, included fixing set, rail system for optional accommodation of lamp LE.2/ LE.3

**Art. No.**

w/h/d 1200/800/45 mm

6736 002 899





Mirror  
**SP . 2**  
1000 x 800 x 45mm

Xplore.S  
Washplace  
**WP . XS2**  
645 x 300 x 268mm

# Accessories



Overflow rosette

**UR . 1**

Matt black

Drain valve, valve cap

**VT . 5**

White

Work.Frame

Washplace

**WP . WF20 . 1**

1000 x 900 x 525 mm

## Accessories

### SI. 2



Bottle trap, w/h/d 45/297/370 mm, chrome-plated, 1 1/4" connection thread, immersion tube, adjustable in height from 135 to 205 mm, adjustable depth from 90 to 370 mm

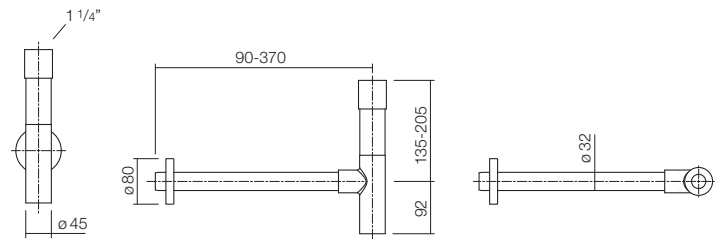

Chrome-plated

**Art. No.**

8306 000 978

### SI. 3



Bottle trap, w/h/d 45/419.5/390 mm, 1 1/4" connection thread, immersion tube, adjustable in height from 75 to 330 mm, adjustable depth from 90 to 390 mm

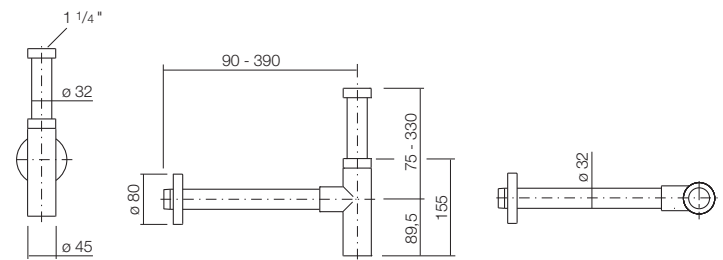

Chrome-plated  
matt black  
white

**Art. No.**

8312 000 978

8312 000 980

8312 000 331

### EV. 3



Angle valve cover, w/h/d 45/351/49 mm, chrome-plated

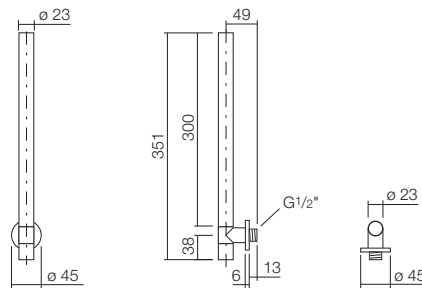

Chrome-plated

**Art. No.**

8110 000 978

### VT. 1



Drain valve, round, w/h/d 63/74/63 mm, chrome-plated, Ø 1 1/4", with open/closed function, this basin requires an overflow, valve cap, chrome-plated

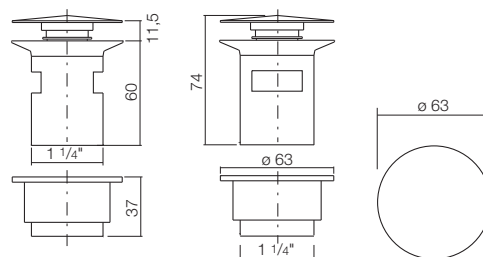

Chrome-plated

**Art. No.**

8302 000 978

## Accessories

### VT . 2



Drain valve, round, w/h/d 63/100/63 mm, Ø 1 1/4", for basins without overflow, valve cap

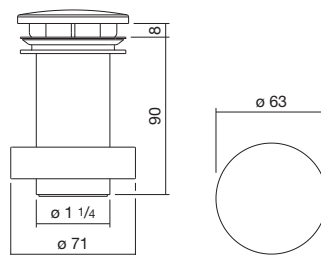

Chrome-plated  
White glazed

#### Art. No.

8304 000 978  
8304 000 000

### VT . 3



Drain valve, round, w/h/d 74/100/74 mm, Ø 1 1/4", for basins without overflow, valve cap

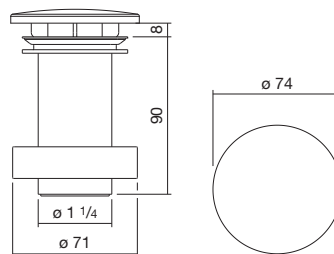

Chrome-plated  
White glazed

#### Art. No.

8305 000 978  
8305 000 000

### VT . 4



Drain valve, round, w/h/d 74/120/74 mm, Ø 1 1/4", with open/closed function, this basin requires an overflow, valve cap, white glazed

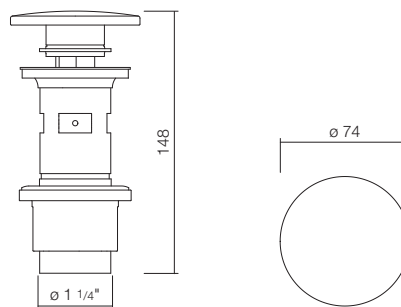

White glazed

#### Art. No.

8319 000 000

### VT . 5



Drain valve, round, w/h/d 74/106/74 mm, Ø 1 1/4", this basin requires an overflow, valve cap

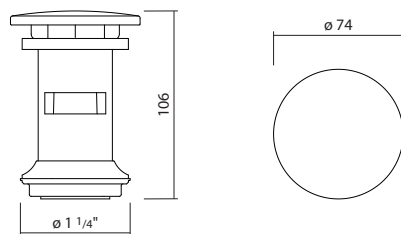

Chrome-plated  
White glazed

#### Art. No.

8320 000 978  
8320 000 000

## Accessories

### UR.1



Overflow rosette, round, w/h/d 36/36/14 mm, suitable for Alape overflow set

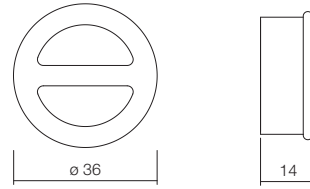

matt black  
platinum matt  
white

#### Art. No.

8321 000 980  
8321 000 330  
8321 000 331

### Overflow set B.1



Overflow set, w/h/d 70/235/mm, equipped for eccentric and drain valve, for basins and washstands with overflow

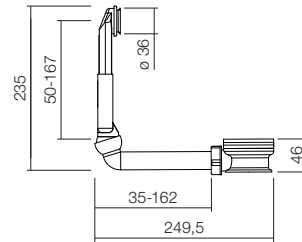

#### Art. No.

9500 280 000

### Overflow set C



Overflow set, w/h/d 70/50/87 mm, equipped for drain and universal valve, for basins and washstands without overflow

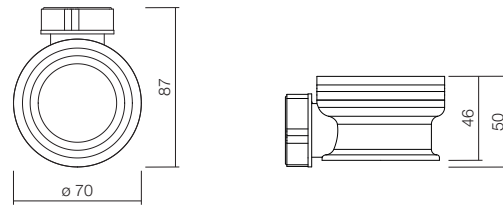

#### Art. No.

9500 410 000

# Spare parts

Below you will find spare parts for our extensive range of washbasins, washstands and washplaces. The selection ranges from valve caps in different shapes, sizes and colours to siphons and accessory bags for bucket sinks. You will find the article number of the required spare part in the assembly instructions for your product. If you miss a spare part, please send a message to [service@alape.com](mailto:service@alape.com). We will be happy to advise you.

Article	Short name	Description
<b>Valve caps</b>		
9510 001 000	Valve cap	Valve cap, square, w/h/d 68/23/68 mm, white, glazed, with base body
9510 002 000	Valve cap	Valve cap, oval, w/h/d 390/35/90 mm, white, glazed, with base body
9510 006 000	Valve cap	Valve cap, round, w/h/d 65/30/65 mm, plastic, chrome-plated, with base body
9510 007 000	Valve cap	Valve cap, round, w/h/d 75/30/75 mm, plastic, chrome-plated, with base body
9510 009 000	Valve cap	Valve cap, round, w/h/d 63/31/63 mm, white, glazed, Ø 63 mm, suitable for basins without overflow with Alape 11/4" drain valve, with base body
9510 009 180	Valve cap	Valve cap, round, w/h/d 63/31/63 mm, bicolor, glazed, Ø 63 mm, suitable for basins without overflow with Alape 11/4" drain valve, with base body
9510 009 190	Valve cap	Valve cap, round, w/h/d 63/31/63 mm, dark iron, glazed, Ø 63 mm, suitable for basins without overflow with Alape 11/4" drain valve, with base body
9510 010 000	Valve cap	Valve cap, round, w/h/d 74/31/74 mm, white, glazed, Ø 74 mm, suitable for basins without overflow with Alape 11/4" drain valve, with base body
9510 010 180	Valve cap	Valve cap, round, w/h/d 74/31/74 mm, bicolor, glazed, Ø 74 mm, suitable for basins without overflow with Alape 11/4" drain valve, with base body
9510 010 190	Valve cap	Valve cap, round, w/h/d 74/31/74 mm, dark iron, glazed, Ø 74 mm, suitable for basins without overflow with Alape 11/4" drain valve, with base body
9510 018 000	Valve cap	Valve cap, round, w/h/d 84/32/84 mm, white, glazed, Ø 74 mm, suitable for basins without overflow with Alape 11/4" drain valve, with base body
9510 018 081	Valve cap	Valve cap, round, w/h/d 84/32/84 mm, oyster matt, glazed, Ø 74 mm, suitable for basins without overflow with Alape 11/4" drain valve, with base body
9510 018 082	Valve cap	Valve cap, round, w/h/d 84/32/84 mm, silk matt, glazed, Ø 74 mm, suitable for basins without overflow with Alape 11/4" drain valve, with base body
9510 018 083	Valve cap	Valve cap, round, w/h/d 84/32/84 mm, nordic matt, glazed, Ø 74 mm, suitable for basins without overflow with Alape 11/4" drain valve, with base body
9510 018 084	Valve cap	Valve cap, round, w/h/d 84/32/84 mm, gravel matt, glazed, Ø 74 mm, suitable for basins without overflow with Alape 11/4" drain valve, with base body
9510 018 091	Valve cap	Valve cap, round, w/h/d 84/32/84 mm, deep green, glazed, Ø 74 mm, suitable for basins without overflow with Alape 11/4" drain valve, with base body
9510 018 092	Valve cap	Valve cap, round, w/h/d 84/32/84 mm, deep blue, glazed, Ø 74 mm, suitable for basins without overflow with Alape 11/4" drain valve, with base body
9510 018 093	Valve cap	Valve cap, round, w/h/d 84/32/84 mm, deep indigo, glazed, Ø 74 mm, suitable for basins without overflow with Alape 11/4" drain valve, with base body
9510 019 081	Valve cap	Valve cap, round, w/h/d 92/32/92 mm, oyster matt, glazed, Ø 74 mm, suitable for basins without overflow with Alape 11/4" drain valve, with base body
9510 019 082	Valve cap	Valve cap, round, w/h/d 92/32/92 mm, silk matt, glazed, Ø 74 mm, suitable for basins without overflow with Alape 11/4" drain valve, with base body
9510 019 083	Valve cap	Valve cap, round, w/h/d 92/32/92 mm, nordic matt, glazed, Ø 74 mm, suitable for basins without overflow with Alape 11/4" drain valve, with base body
9510 019 084	Valve cap	Valve cap, round, w/h/d 92/32/92 mm, gravel matt, glazed, Ø 74 mm, suitable for basins without overflow with Alape 11/4" drain valve, with base body
9510 019 091	Valve cap	Valve cap, round, w/h/d 92/32/92 mm, deep green, glazed, Ø 74 mm, suitable for basins without overflow with Alape 11/4" drain valve, with base body
9510 019 092	Valve cap	Valve cap, round, w/h/d 92/32/92 mm, deep blue, glazed, Ø 74 mm, suitable for basins without overflow with Alape 11/4" drain valve, with base body
9510 019 093	Valve cap	Valve cap, round, w/h/d 92/32/92 mm, deep indigo, glazed, Ø 74 mm, suitable for basins without overflow with Alape 11/4" drain valve, with base body
9510 950 590	Valve cap	Valve cap, round, w/h/d 63/32/63 mm, brass, chrome-plated, with base body
9510 950 591	Valve cap	Valve cap, round, w/h/d 73/32/73 mm, brass, chrome-plated, with base body

Article	Short name	Description
<b>Bottle traps</b>		
9510 351 051	Bottle trap	Bottle trap, w/h/d 80/206/384 mm, for surface mounting, height adjustable, with horizontal outlet, plastic, white, connection thread 1 1/4 "
9510 351 058	Bottle trap	Bottle trap, w/h/d 75/337/710 mm, plastic, white, 1 1/4" connection thread
9510 351 950	Bottle trap	Bottle trap, w/h/d 66/268/417 mm, flexible outlet hose, plastic, white, connection thread 1 1/4 "
9510 430 307	Bottle trap	Bottle trap, w/h/d 45/296/370 mm, chrome-plated, 1 1/4" connection thread
9510 950 491	Bottle trap	Bottle trap, w/h/d 48/48/222 mm, plastic, white
9510 950 492	Bottle trap	Bottle trap, w/h/d 85/222/284 mm, plastic, white, 1 1/4" connection thread
<b>Other spare parts</b>		
9510 106 118	Enamel paint	Enamel paint, w/h/d 87/14/21 mm, one-component, for repairs, tube content 8 ml, white
9510 350 996	Installation accessory bag	Installation accessory bag, w/h/d 80/21/80 mm, 3-part, consisting of spacer ring, seal and flange nut
9510 351 823	Plastic bottle	Plastic bottle, w/h/d 75/211/75 mm, amber, incl. black dispenser
9510 950 011	Installation accessory bag	Installation accessory bag, w/h/d 483/5/483 mm, 5-part, consisting of mounting brackets (4 pieces) and PVC seal, white
9510 950 042	Installation accessory bag	Installation accessory bag, w/h/d 277/31/50 mm, 5-part, consisting of mounting brackets (4 pieces) and adhesive cartridge for basin assembling, 70 ml, white
9510 950 086	Adhesive	Adhesive, w/h/d 277/31/50 mm, one-component, for basin assembling, cartridge content 70 ml, white
9510 951 078	Overflow rosette	Overflow rosette, round, w/h/d 36/36/14 mm, plastic, white
9511 000 001	Installation accessory bag	Installation accessory bag, w/h/d 505/219/6 mm, 12-part, consisting of drain valve (6-part), chain with plug, plastic cover caps (2 pieces), grommet (2 pieces) and PVC edge profile (grey)
9511 000 003	Installation accessory bag	Installation accessory bag, w/h/d 36/153/100 mm, 20-part, consisting of drain valve (5-part), chain with stopper, plastic cover caps (2 pieces), grommet (2 pieces), screws (2 pieces) and overflow set (7-part)

# Mounting and Connection Measurements

The following mounting and connection measurements can also be downloaded at [www.alape.com](http://www.alape.com).

Our hotline is available to answer your questions in more detail. You can reach our service team on +49(0)5321.558111.





### Mounting and connection measurements

**SP . 300C**  
No. 6720 000 899

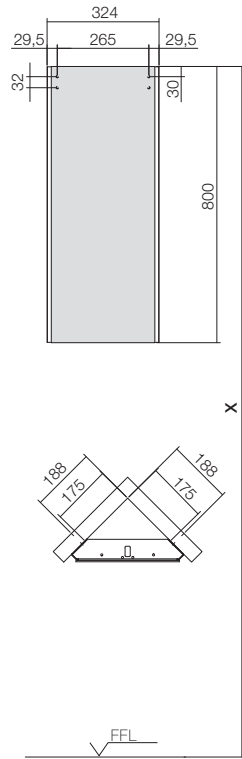

**SP . 300**  
No. 6719 000 899

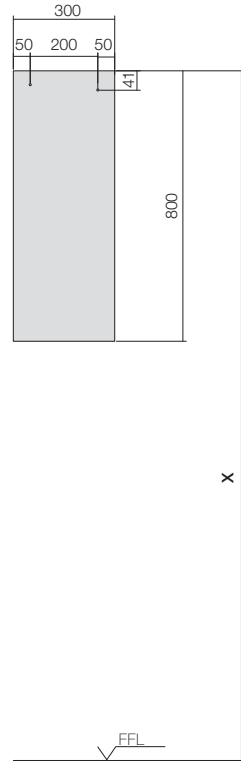

**SP . 325**  
No. 6716 000 899

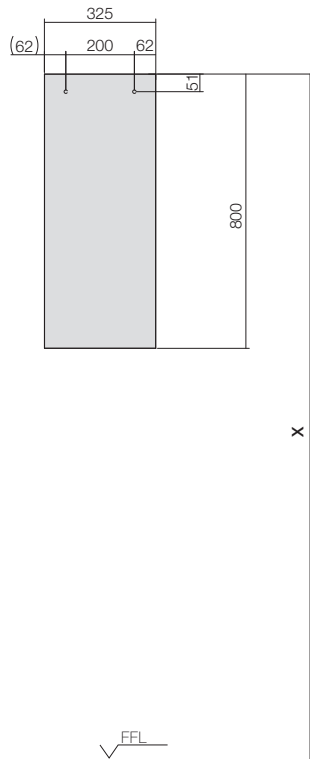

**SP . 450**  
No. 6717 000 899

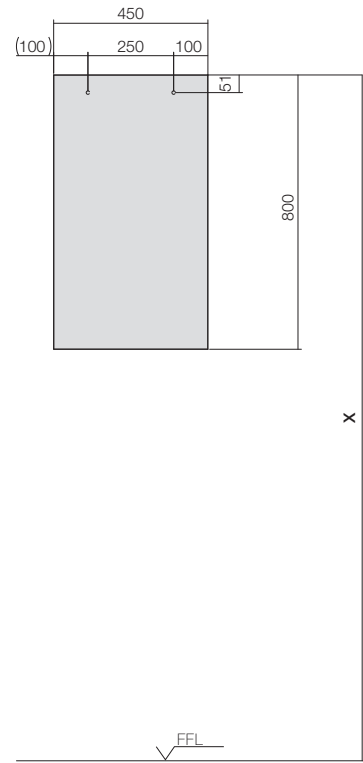

**Mounting and connection measurements**

**SP . 2**

No. 6736 OXX 899

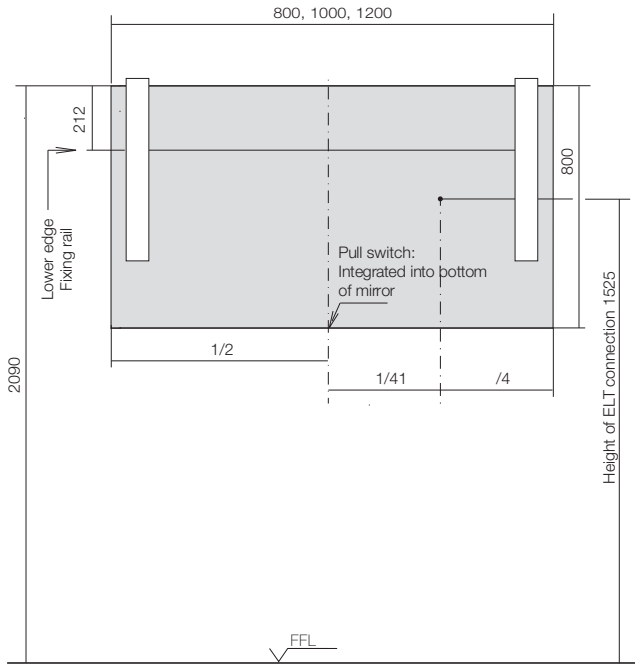

**WT . RX400H . CU**  
No. 4508 800 000

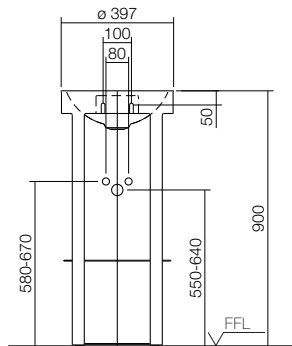

**WT . RX400H . CR**  
No. 4509 800 240

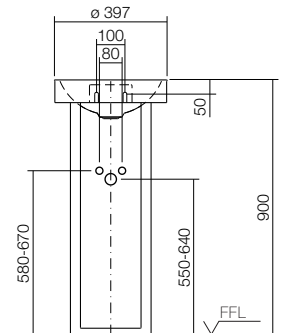

**WT . RX400 . CU**  
No. 4508 500 000

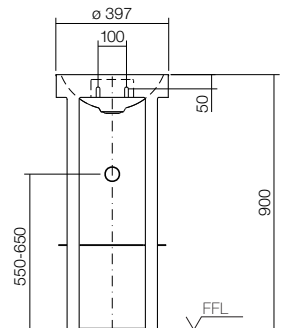

**WT . RX400 . CR**  
No. 4509 500 240

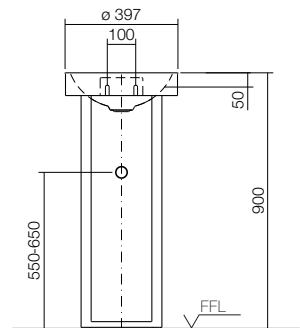

# Mounting and connection measurements

## WT . RX325K

No. 4501 000 000 – with wall bracket cover

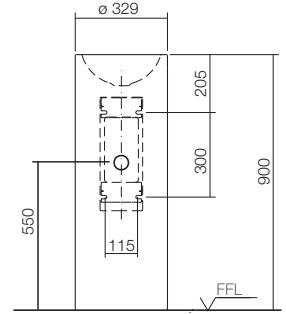

## WT . RX400KH

No. 4500 000 000 – with wall bracket cover

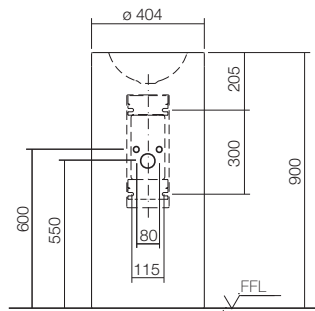

## WT . RX400K

No. 4503 000 000 – with wall bracket cover

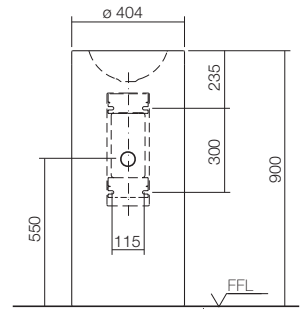

## WT . RX325 . KE

No. 4505 500 000 – with wall bracket cover

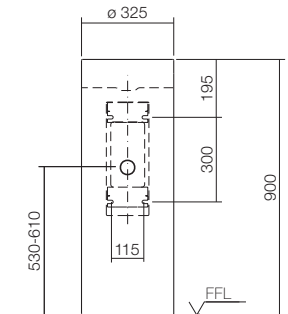

## WT . RX400 . KE

No. 4506 500 000 – with wall bracket cover

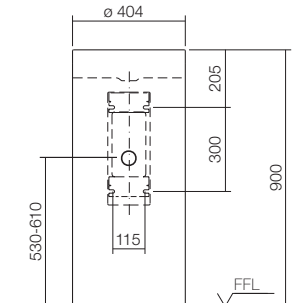

## WT . RX400H . CO

No. 4507 800 000 – with wall bracket cover

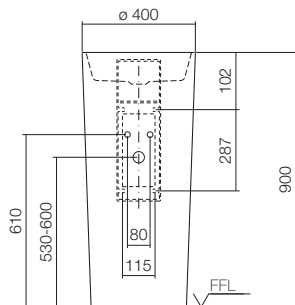

## WT . RX400 . CO

No. 4507 500 000 – with wall bracket cover

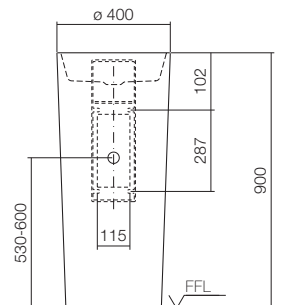



### Mounting and connection measurements

**WT.IC325H**  
No. 4236 000 000

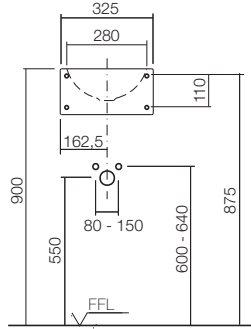

**WT.IC600H**  
No. 4238 000 000

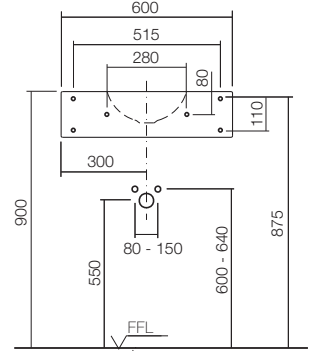

**WT.IC600H.R**  
No. 4240 000 000

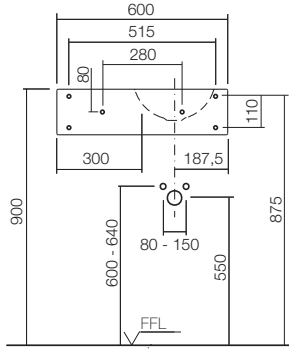

**WT.IC600H.L**  
No. 4239 000 000

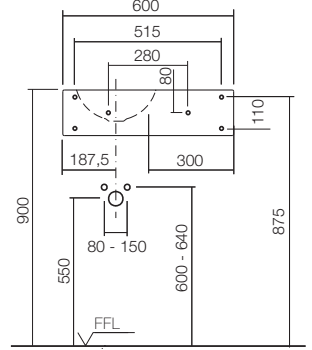

**WT.MC450H**  
No. 4228 000 000

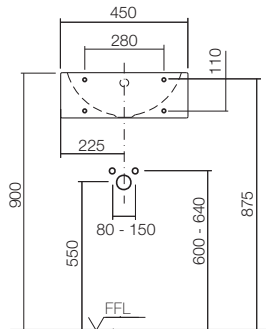

**WT.MC800H**  
No. 4230 000 000

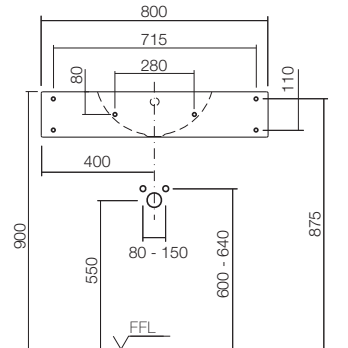

**WT.MC800H.L**  
No. 4231 000 000

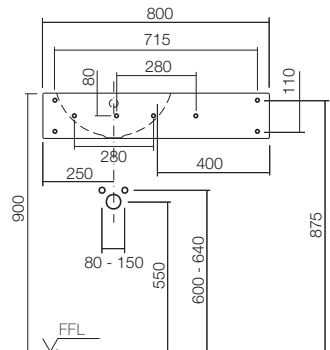

**WT.MC800H.R**  
No. 4232 000 000

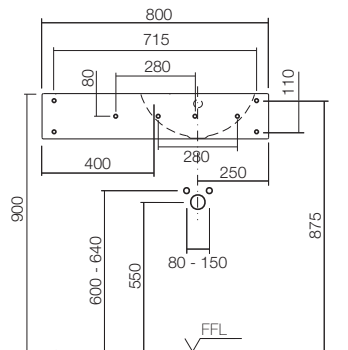

**Mounting and connection measurements**

**WT.XXS450H.L**  
No. 4295 000 000

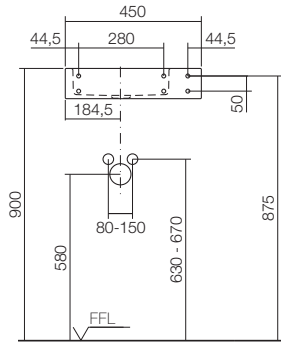

**WT.XXS450H.R**  
No. 4297 000 000

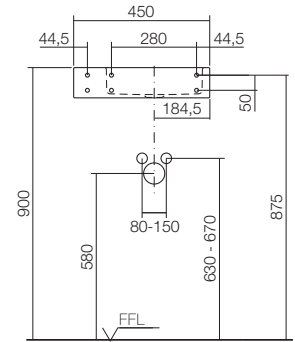

**WT.XXS450.L**  
No. 4296 000 000

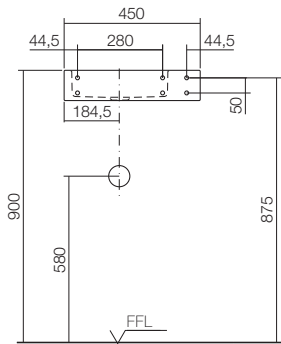

**WT.XXS450.R**  
No. 4298 000 000

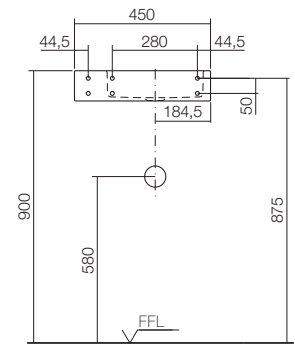

**WT.XS500H.L**  
No. 4290 000 000

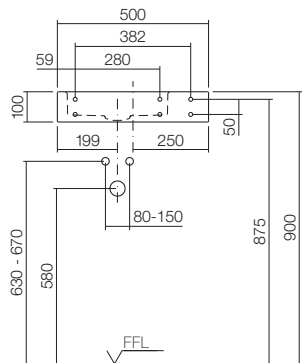

**WT.XS500H.R**  
No. 4292 000 000

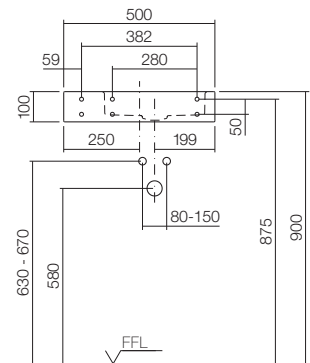

**WT.XS500.L**  
No. 4291 000 000

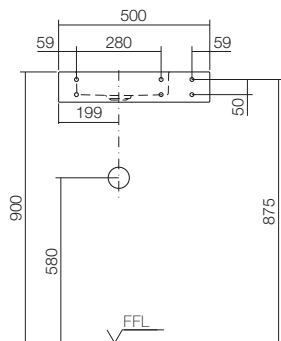

**WT.XS500.R**  
No. 4293 000 000

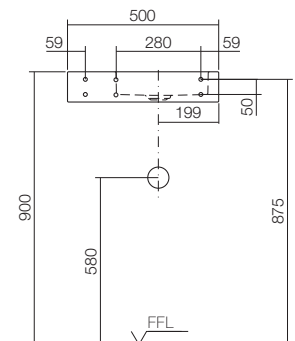

**Mounting and connection measurements**

**WT.QS325H**  
No. 4277 000 000

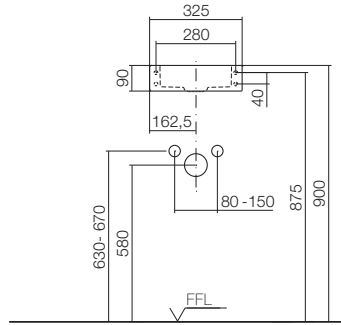

**WT.QS325**  
No. 4270 000 000

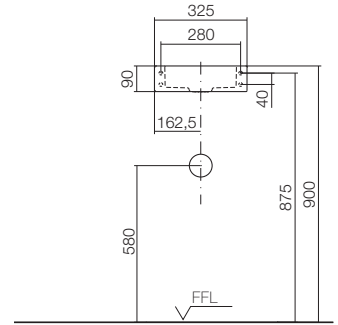

**WT.QS325X**  
No. 4271 000 000 – Visible drain

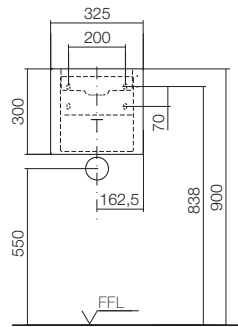

**WT.QS325X**  
No. 4271 000 000 – Covered drain

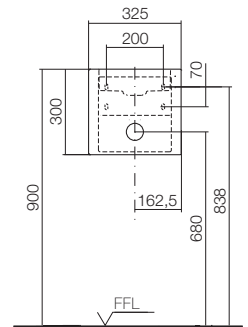

We recommend:  
Viega chrome-plated  
pipe siphon for bidet  
modell 5535  
product no. 103781  
Firma Viega

**WT.QS525H.L**  
No. 4279 000 000

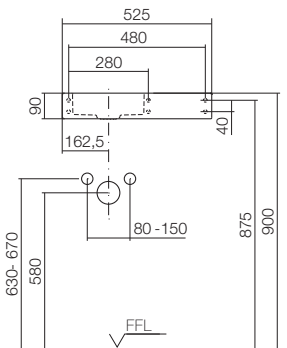

**WT.QS525H.R**  
No. 4280 000 000

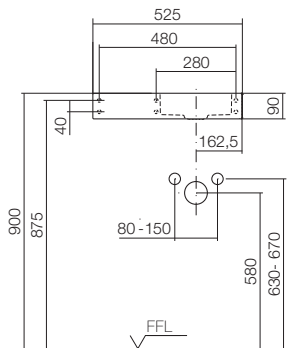

**WT.QS525.L**  
No. 4273 000 000

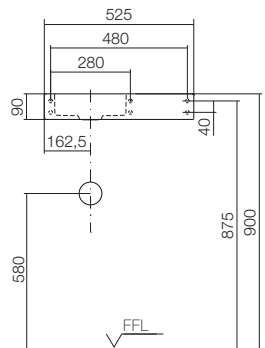

**WT.QS525.R**  
No. 4274 000 000

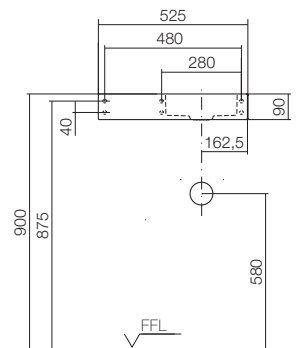

**WT.QS450H**  
No. 4276 000 000

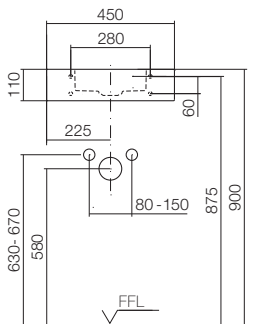

**WT.QS450**  
No. 4275 000 000

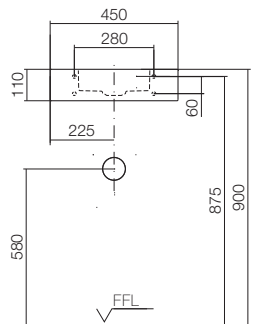

**WT.QS450HX**  
No. 4278 000 000

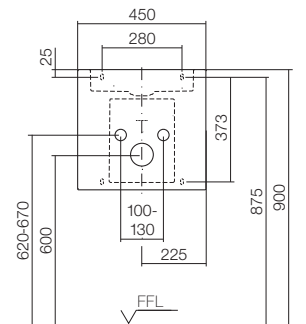

## Mounting and connection measurements

**WT.SR800H.R**  
No. 4282 600 000

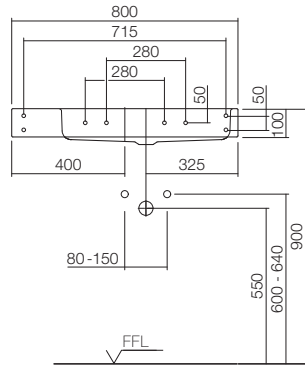

**WT.SR800H.L**  
No. 4281 600 000

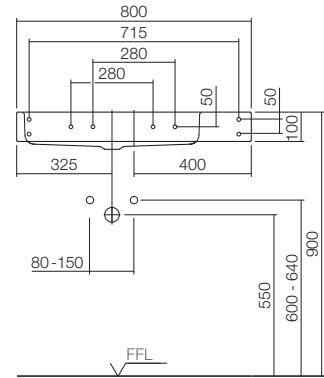

**WT.PR585H**  
No. 4201 000 000

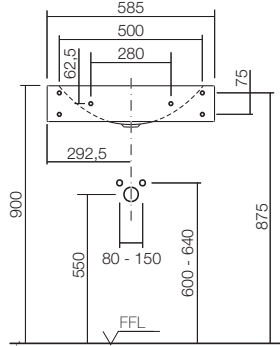

**WT.PR585**  
No. 4200 000 000

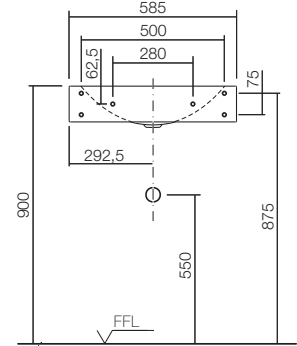

**WT.PR800H**  
No. 4203 000 000

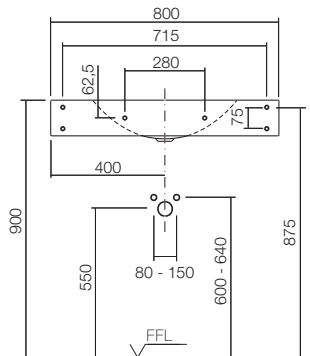

**WT.PR800**  
No. 4203 300 000

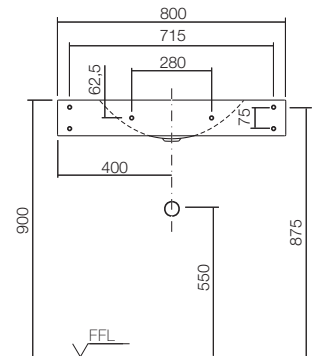

**WT.PR800H.L**  
No. 4205 000 000

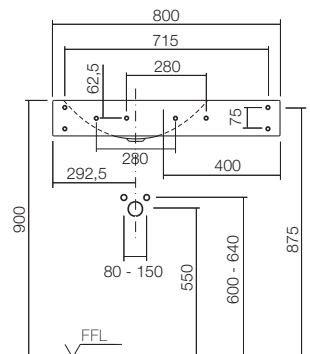

**WT.PR800H.R**  
No. 4207 000 000

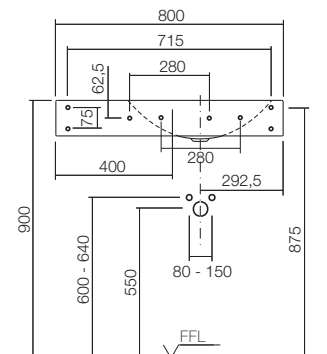



**Mounting and connection measurements**

**WT.PR800.L**  
No. 4205 300 000

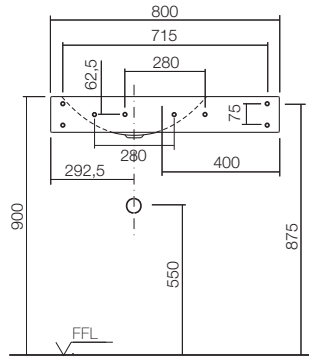

**WT.PR800.R**  
No. 4207 300 000

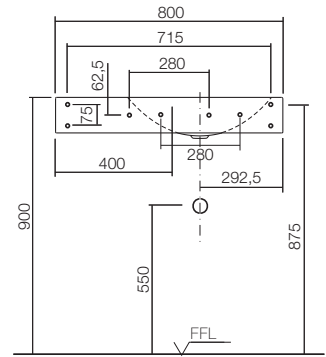

**WT.GR800H**  
No. 4261 000 000

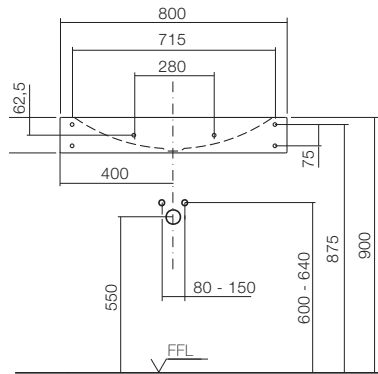

**WT.GR1250H**  
No. 4287 000 000

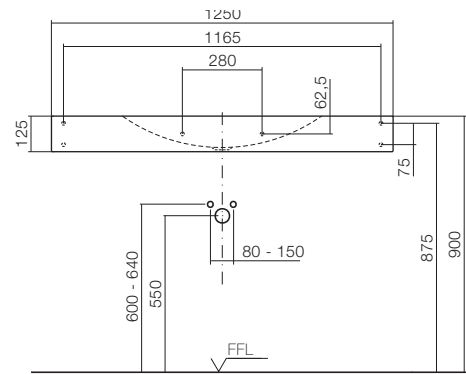

**WT.GR1250H.L**  
No. 4288 000 000

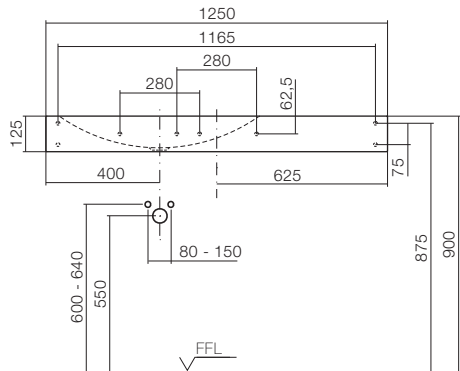

**WT.GR1250H.R**  
No. 4289 000 000

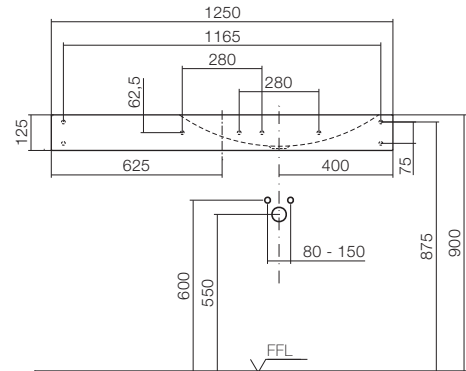

**WT.RE800H**  
No. 4105 000 000

In case of deviating connection measurements, it should be ensured that a bottle trap with an immersion tube of approx. 300mm in length is used (e.g. SI.3 by Alape, see page 167).

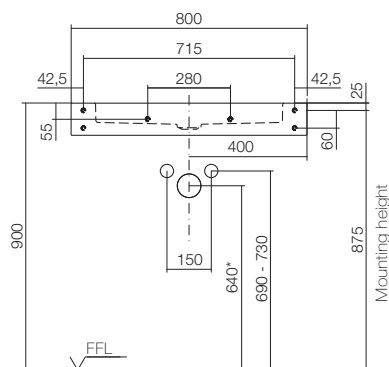

**WT.RE1000H.L**  
No. 4102 000 000

In case of deviating connection measurements, it should be ensured that a bottle trap with an immersion tube of approx. 300mm in length is used (e.g. SI.3 by Alape, see page 167).

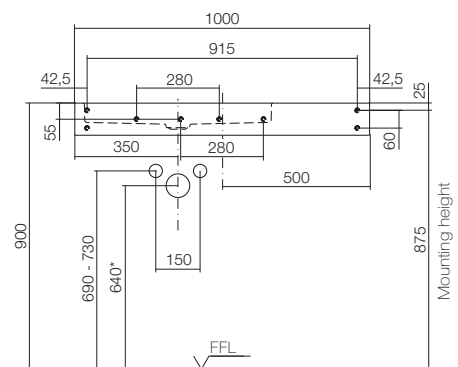

## Mounting and connection measurements

### WT.RE1000H.R

No. 4104 000 000

In case of deviating connection measurements, it should be ensured that a bottle trap with an immersion tube of approx. 300mm in length is used (e.g. Sl.3 by Alape, see page 167).

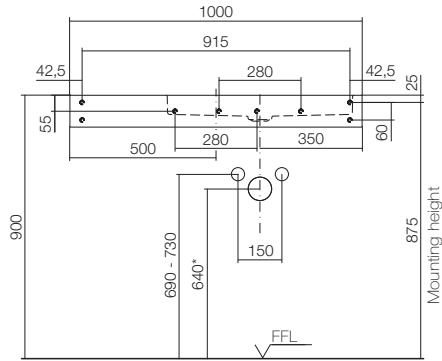

### WP.Insert1

No. 5241 000 000

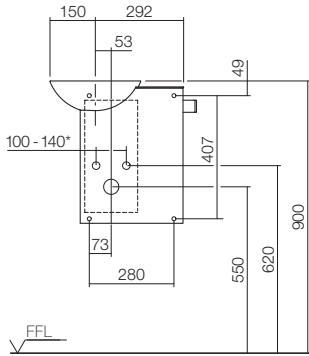

### WP.Insert2

No. 5242 000 000

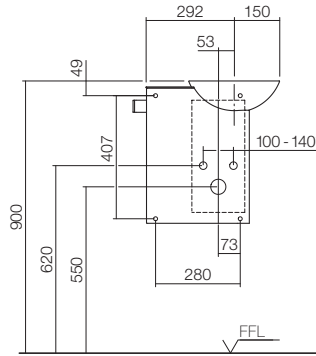

### WP.Insert5

No. 5245 000 000 – connection alternatively left/right side

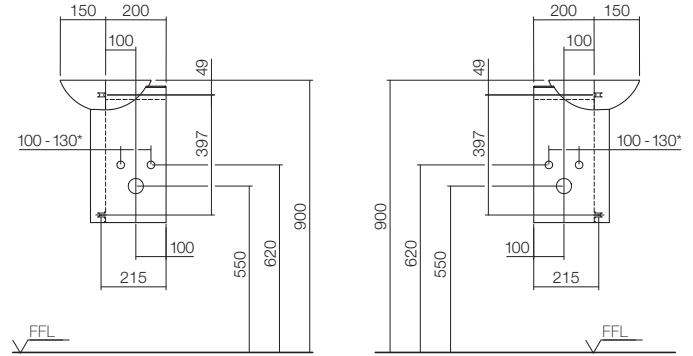

### WP.PN1

No. 5256 000 XXX

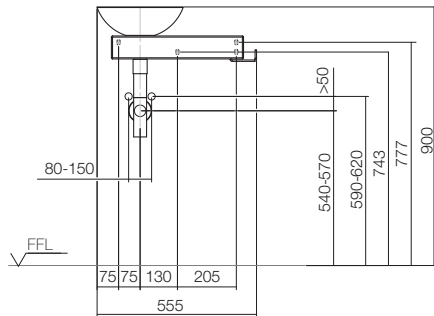

### SET.WP.PN1

No. 0613 001 XXX

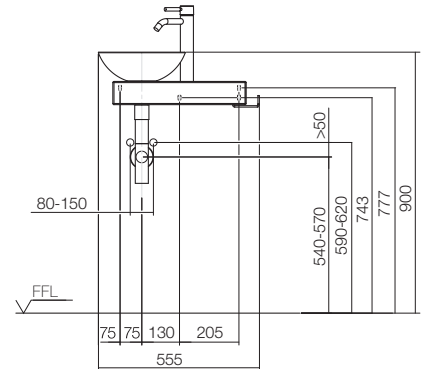

### WP.PN2

No. 5257 000 XXX

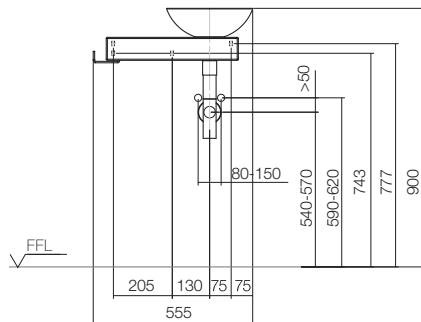

### SET.WP.PN2

No. 0613 002 XXX

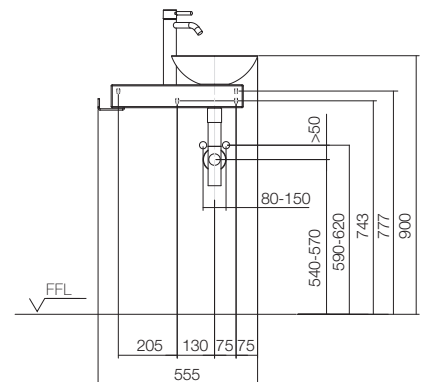

**Mounting and connection measurements**

**WP . XXS1**

No. 5062 800 000 – Visible drain

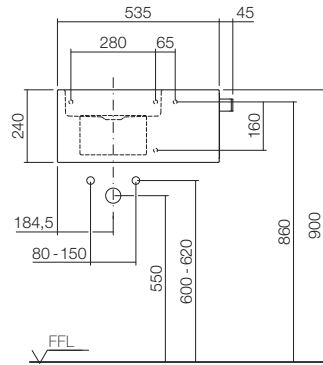

**WP . XXS1**

No. 5062 800 000 – Covered drain

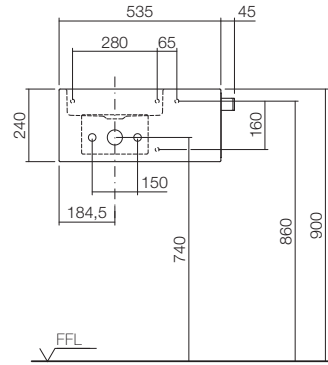

We recommend:  
Viega chrome-plated  
pipe siphon for bidet  
modell 5535  
product no. 103781  
Firma Viega

**WP . XS2**

No. 5065 800 000 – Visible drain

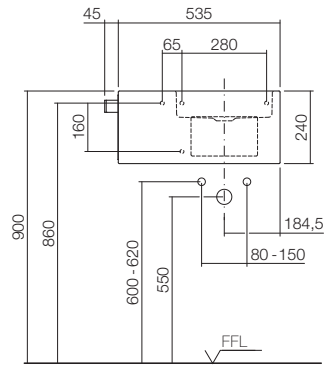

**WP . XS2**

No. 5065 800 000 – Covered drain

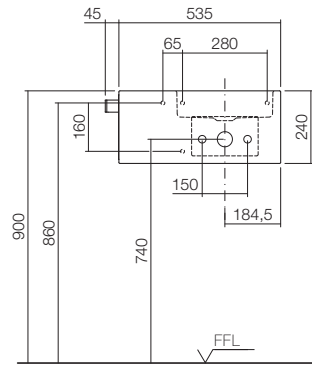

We recommend:  
Viega chrome-plated  
pipe siphon for bidet  
modell 5535  
product no. 103781  
Firma Viega

**WP . XS1**

No. 5072 800 000 – Visible drain

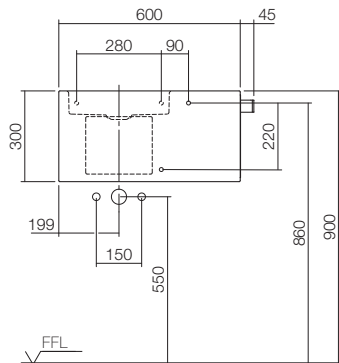

**WP . XS1**

No. 5072 800 000 – Covered drain

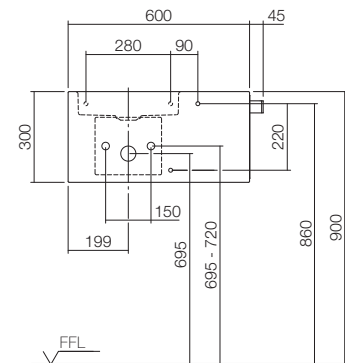

We recommend:  
Viega chrome-plated  
pipe siphon for bidet  
modell 5535  
product no. 103781  
Firma Viega

**WP . XS2**

No. 5075 800 000 – Visible drain

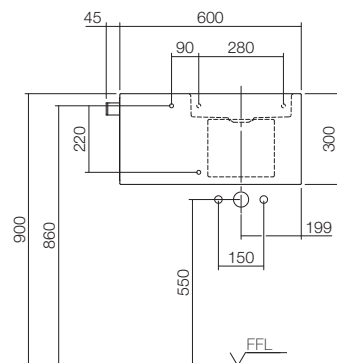

**WP . XS2**

No. 5075 800 000 – Covered drain

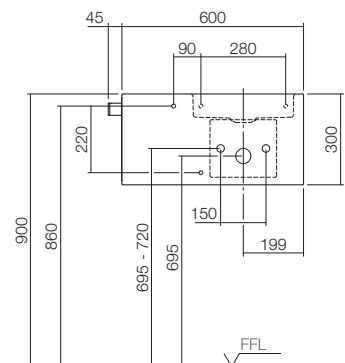

We recommend:  
Viega chrome-plated  
pipe siphon for bidet  
modell 5535  
product no. 103781  
Firma Viega

## Mounting and connection measurements

### WP . S19 . 1

No. 5260 000 000

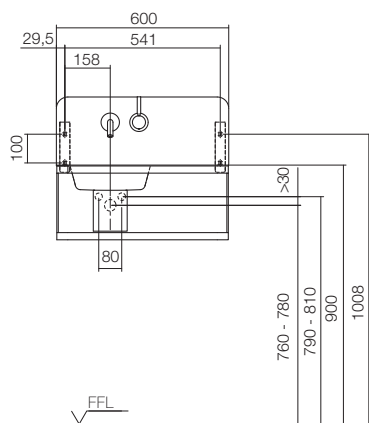

### WP . S19 . 1R

No. 5266 000 000

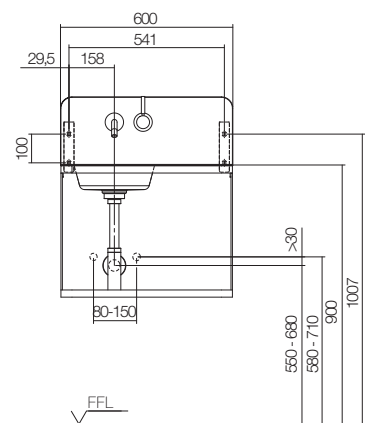

Depending on the mounting height of angle valves, an on-site adaption (tap extension 100mm) or an extension of pressure hoses will be necessary.

### WP . S19L . 1

No. 5261 000 000

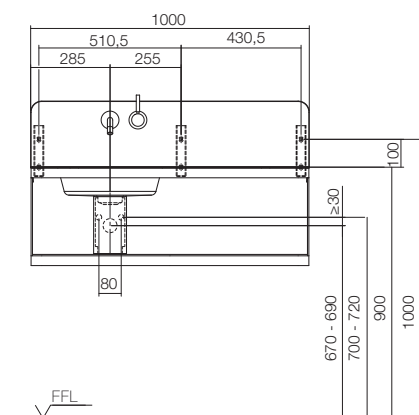

### WP . S19L . 1R

No. 5267 000 000

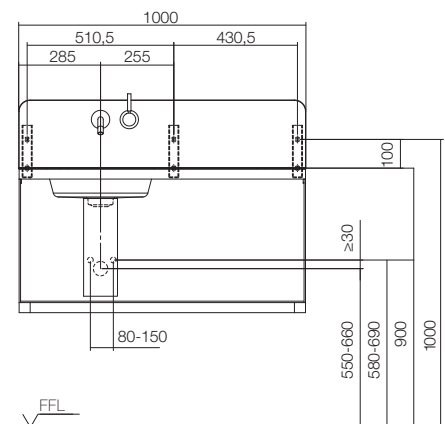

Depending on the mounting height of angle valves, an on-site adaption (tap extension 100mm) or an extension of pressure hoses will be necessary.

### WP . S19L . 2

No. 5262 000 000

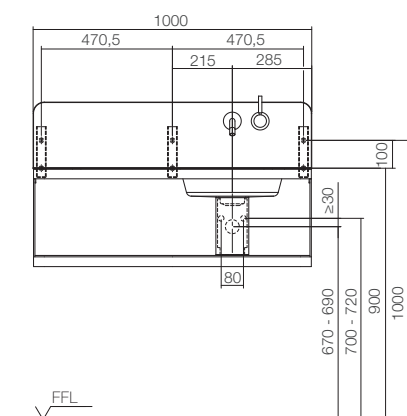

### WP . S19L . 2R

No. 5268 000 000

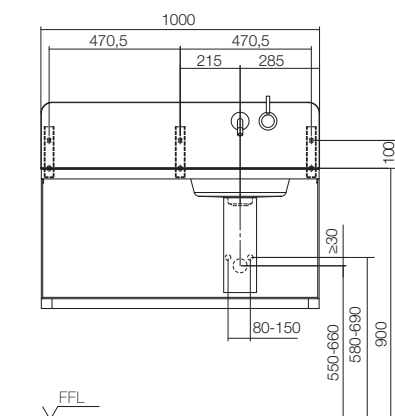

Depending on the mounting height of angle valves, an on-site adaption (tap extension 100mm) or an extension of pressure hoses will be necessary.

**Mounting and connection measurements**

**WP.WF20.1**  
No. 5271 000 000

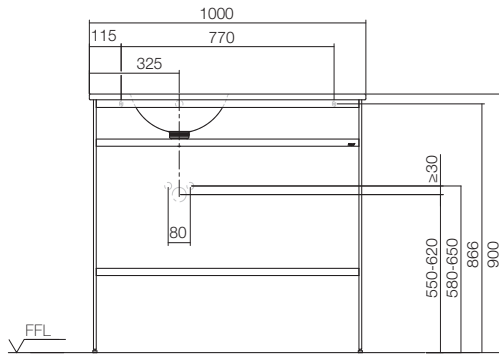

with SV.WF20.1.2  
8113 000 980

**WP.WF20.1**  
No. 5271 000 000

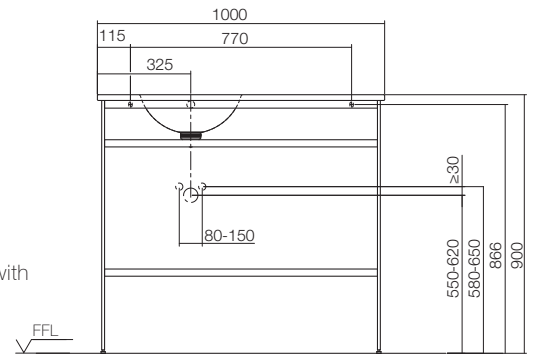

For renovation with  
SV.WF20.1R /  
8113 999 980

**WP.WF20.2**  
No. 5272 000 000

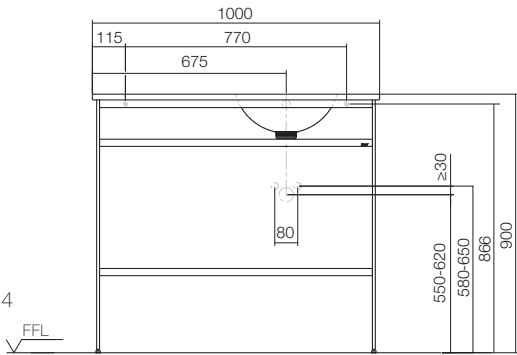

with SV.WF20.3.4  
8113 000 980

**WP.WF20.2**  
No. 5272 000 000

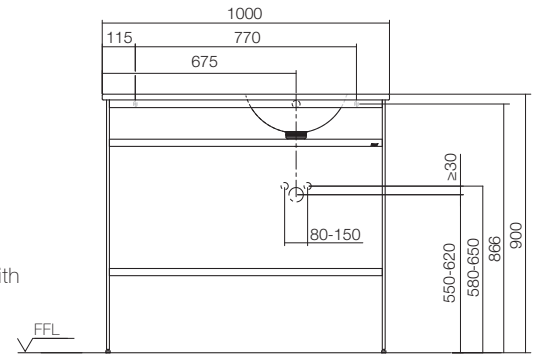

For renovation with  
SV.WF20.1.2R  
8113 999 980

**WP.WF20.3**  
No. 5273 000 000

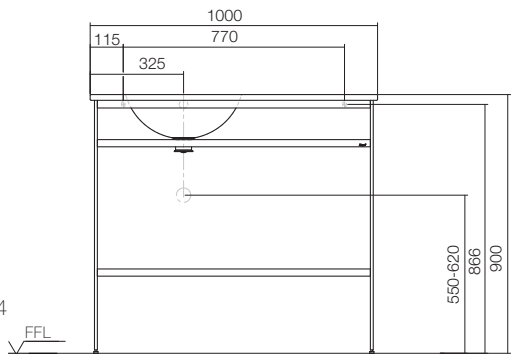

with SV.WF20.3.4  
8114 000 980

**WP.WF20.4**  
No. 5274 000 000

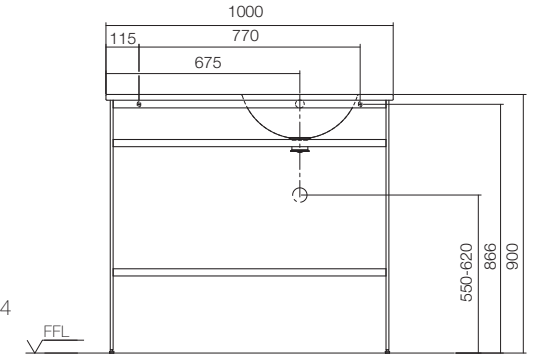

with SV.WF20.3.4  
8114 000 980

**WP.WF100.1**  
No. 5270 000 000

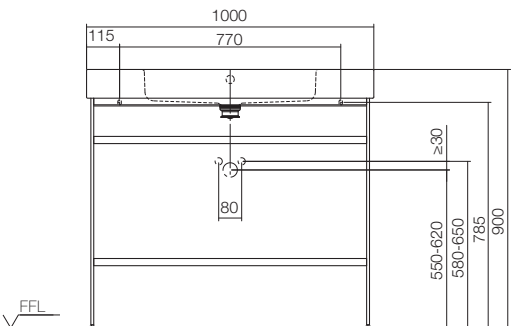

with SV.WF100.1  
8112 000 980

**WP.WF100**  
No. 5270 000 000

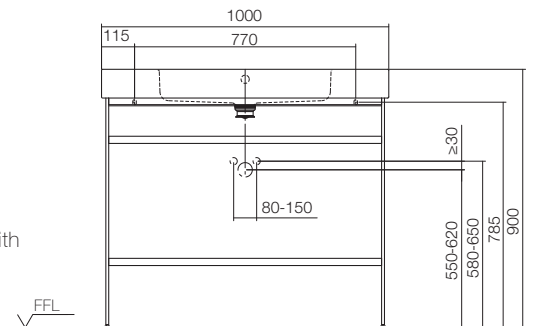

For renovation with  
SV.WF100.1  
8112 999 980

## Mounting and connection measurements

### WP.Folio11

No. 5161 8XX 000

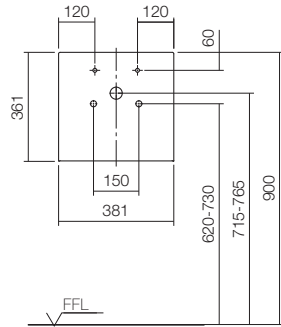

### WP.Folio12

No. 5161 5XX 000

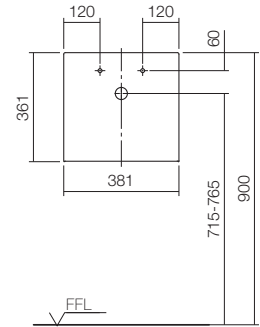

### WP.Folio1

No. 5155 8XX 000

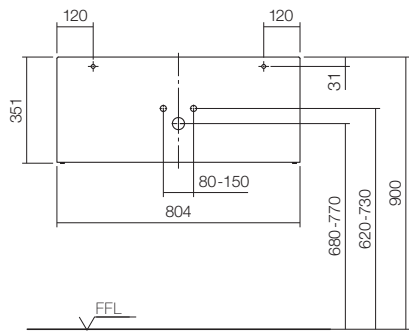

### WP.Folio2

No. 5155 5XX 000

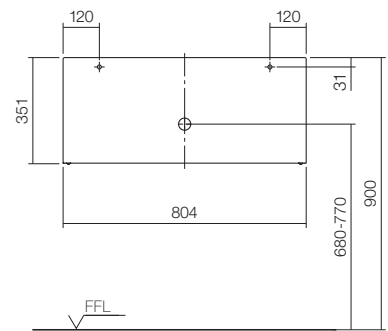

### WP.Folio3

No. 5156 8XX 000

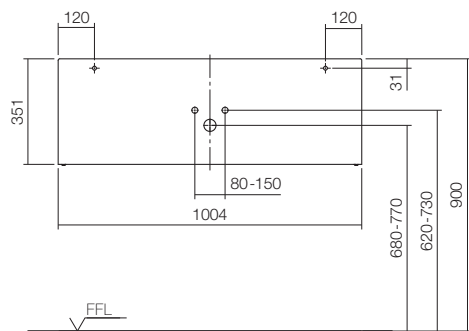

### WP.Folio4

No. 5156 5XX 000

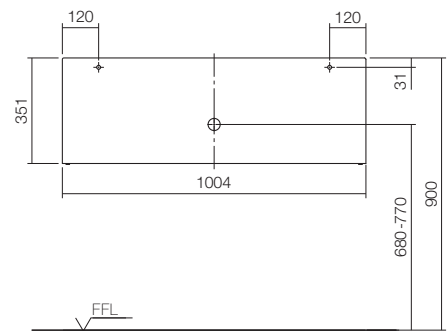

### WP.Folio5

No. 5157 8XX 000

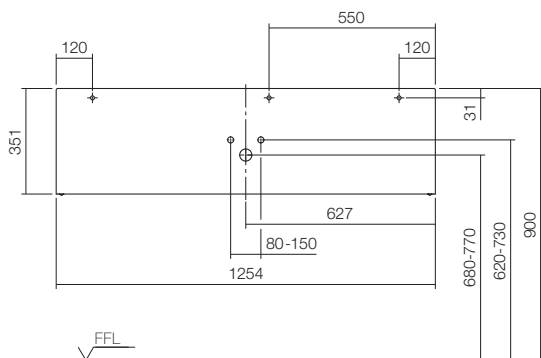

### WP.Folio6

No. 5157 5XX 000

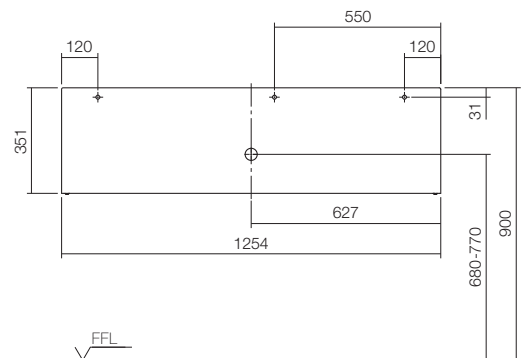

# Mounting and connection measurements

Washplaces

Bucket sinks

Assist Shelves

Mirrors/Lighting

Accessories

Spare parts

Installation

**WP.Folio7**  
No. 5158 8XX 000

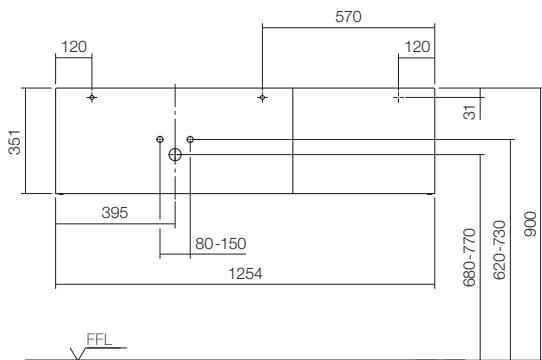

**WP.Folio8**  
No. 5158 5XX 000

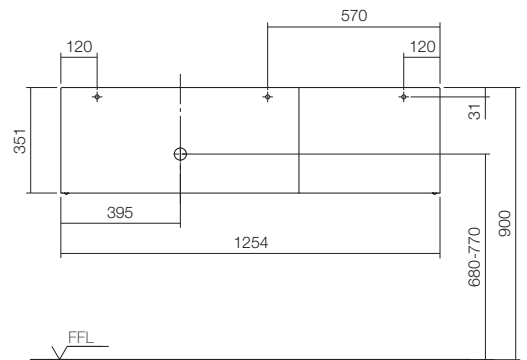

**WP.Folio9**  
No. 5159 8XX 000

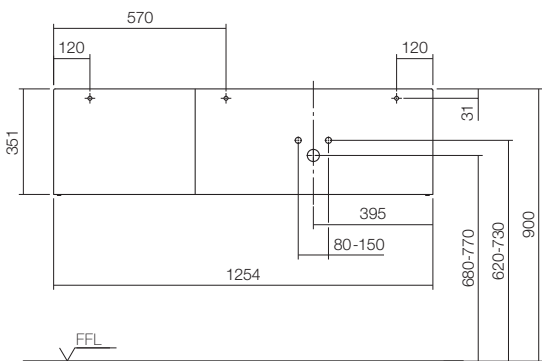

**WP.Folio10**  
No. 5159 5XX 000

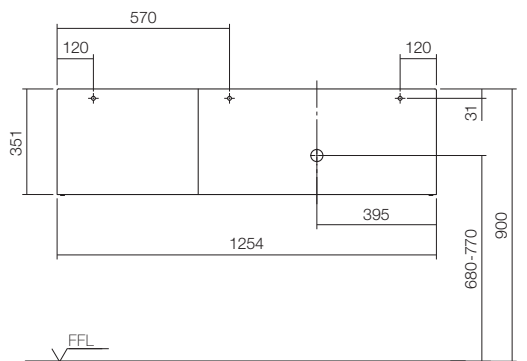

## Terms of Trading and Delivery

### Terms and Conditions of Sale, Delivery and Payment

#### 1. GENERAL

1.1. The following terms apply exclusively to all of our quotations, sales and deliveries. We do not accept purchaser's terms of business that conflict with or differ from our Terms and Conditions, unless we have expressly agreed to them in writing. Differing arrangements apply only to a specific contract and not to subsequent contracts, save where expressly otherwise agreed.

1.2. All agreements, subsidiary agreements and contractual amendments must be made in writing. This applies equally to any revocation of this clause governing written form. To be effective, verbal or written agreements deviating from our contractual conditions and/or the order confirmation must be approved by the proper number of directors or authorised officers. Neither our office staff nor field staff are authorised to make differing agreements or to grant special terms.

#### 2. INFORMATION, ADVICE

All information and advice given in respect of our products is based on our previous experience. Figures quoted are average values found from such experience. Any information or advice provided does not obviate the need for the goods supplied to be tested for suitability nor for compliance with processing instructions. Any information given verbally is not binding.

#### 3. QUOTATION, CONTRACT SIGNATURE

3.1. All quotations are made subject to contract. A supply contract or any other contract becomes binding on us only when we have confirmed the customer's order or other order in writing or have delivered the goods.

3.2. Samples and trial items are supplied without obligation as goods on approval. Where a purchase is made based on samples and/or trial items it is made subject to deviations standards in the industry and within normal manufacturing tolerances. Unless expressly specified in the order confirmation, the supply of samples or trial items is not linked with any guarantee of quality or service life.

3.3. Samples and trial items are to be returned to us in perfect condition within 4 weeks. If they are not returned within this period, we shall be entitled to charge the list purchase price. Price lists are available on request at any time.

3.4. Save where expressly agreed otherwise, the information provided by us in text or illustrated form (e.g. descriptions, illustrations or drawings) in catalogues, brochures or other publications conclusively defines the quality of the goods we supply and their potential applications. The information we provide is not a guarantee of service life or quality and is based on our current understanding. We accept no liability for successful use of goods supplied.

3.5. Measurements in quotations and brochures are only approximate and apply subject to standard tolerances with enamel goods. All goods are subject to changes in construction made for product development purposes.

#### 4. PRICES

4.1. The prices charged are the prices stated in our binding price list applicable on the day of delivery, save where a fixed price has been expressly agreed in writing.

4.2. All prices are net and exclusive of VAT, which is to be paid by the purchaser at the prevailing statutory rate.

4.3. If there is any increase in our sundry material procurement costs, energy costs or labour costs/incidental wage costs between the date of order confirmation and the date of delivery, we shall be entitled to adjust an agreed fixed price accordingly. The purchaser will be entitled to cancel the contract if the price rise exceeds 5%.

#### 5. DELIVERY

5.1. The delivery periods will begin on the date of our order confirmation, but not before any agreed down payment has been received and not before all of the order details have been finally clarified, the requisite certificates procured and/or all necessary documents provided. The delivery date is deemed to have been met if the subject goods have left our factory or warehouse before this period has expired, or have been notified as ready for delivery if the goods cannot be forwarded on time for reasons beyond our control. Delivery dates are deemed to be approximate where there is no provision to the contrary.

5.2. When a delivery date not expressly designated as 'fixed' in the order confirmation is overrun, the purchaser may set a reasonable extension period for delivery. We can only be in default on expiry of this extension period.

5.3. Without prejudice to our rights arising out of delays in payment by the purchaser, delivery dates will be extended by the period of time that the purchaser fails to honour his obligations to us.

5.4. The right remains for the purchaser to arrange proper and timely delivery himself, as long as we are in no way to be liable for such non-standard delivery.

5.5. Unforeseen, exceptional circumstances beyond our control, such as in-

dustrial action, operational breakdown, government action, transport disruption or other instances of force majeure, irrespective of whether we or our suppliers are affected by such circumstances, will exempt us from our obligations under the relevant contract, although hindrances of a temporary nature shall do so only for the duration of the hindrance and a reasonable start-up time thereafter. The above circumstances are also beyond our control if they arise during a delay that has already occurred. If as a result, delivery subsequently becomes impossible or unreasonable for one of the parties, either party will be entitled to terminate the contract.

5.6. We shall not be liable for any loss due to delays arising from any breach of our contractual obligations caused by minor negligence, save where such a breach leads to injury to life, bodily harm or impaired health. There is no connection between this provision and any change in the burden of proof to the disadvantage of the purchaser.

5.7. Should liability for loss due to delay arise not only from a breach of contractual obligations caused by minor negligence, the purchaser shall, subject to the exclusion of further claims, be entitled only to claim compensation amounting to 0.5% for each full week of delay, up to a maximum of 5 percent in total, of the value of that part of the total delivery that, due to the delay, cannot be used on time or for its contractual purpose.

5.8. We shall be entitled to make part deliveries where acceptable to the purchaser. Part deliveries may be invoiced separately.

#### 6. FORWARDING, TRANSFER OF RISK

6.1. Delivery will be ex works (Goslar), unless otherwise agreed. If Inco-terms have been agreed as the delivery terms, the version applicable on the date of contract signature shall apply.

6.2. If, at the purchaser's request, the goods have been forwarded to a place other than the place of performance, the purchaser will meet all costs thereby incurred. The choice of transit route and carrier will be at our discretion. We and the carrier must be notified in writing by the purchaser of the type and extent of any transit damage immediately upon receipt of the goods. Goods will only be insured against damage, loss or breakage in transit at the purchaser's express request and at his expense.

6.3. Forwarding and transportation are always at the purchaser's risk when goods are supplied ex works. This is also applicable if we make delivery to a third party (drop shipment deliveries) and when goods or empties (reusable packaging) are returned. Even when part deliveries are made, the risk passes to the purchaser as soon as the consignment has been transferred to the carrier or has left our warehouse for forwarding or, in the case of delivery ex works, has left our plant.

6.4. If forwarding is delayed due to circumstances for which the purchaser is responsible, or if the purchaser himself is arranging transportation, risk will pass to the purchaser on notification that the goods are ready for despatch. The purchaser must meet storage charges incurred after risk has been transferred. The monthly storage charge for goods delivered to our factory or warehouse will be 0.5% of the invoice value. Subject to showing good reason for so doing, we reserve the right to levy higher storage charges. Once a reasonable period of time has elapsed to no effect, we shall be entitled to dispose of the goods by other means and to supply the purchaser within a reasonably extended period.

#### 7. PAYMENT

7.1. Payments are to be made in euros (€) and must be free of all charges and postage. They must be remitted only to the bank indicated by us. Payment by cheque will be deemed to have been made only when cashed. Cheques are accepted with no obligation for timely presentation or protest.

7.2. Unless expressly agreed otherwise, payments must be made within 10 days of the invoice date at a 2% discount and within 30 days of the invoice date with no deduction. There will be no discount entitlement if previous outstanding invoices remain unpaid.

7.3. If the deadline allowed for payment is exceeded, we shall be entitled to charge interest at 8 percentage points above base (Section 247 of the German Civil Code [BGB]). All of our outstanding accounts will also become immediately due.

7.4. The off-setting of any counter-claims by the purchaser is permissible only if such counter-claims are undisputed or established in law. In the event of deficient deliveries, the purchaser may at most withhold a sum amounting to three times the cost of subsequent work to make good such deliveries. When exercising his right of retention, the purchaser agrees to pay as security the amount of the unpaid portion by bank guarantee or, at our discretion, by depositing it with a notary of his choosing.

#### 8. RETENTION OF TITLE

8.1. All goods supplied shall remain our property (retained-title goods) pending settlement of all financial claims, made on any legal grounds whatsoever, including all future and conditional claims arising from contracts signed



## Terms of Trading and Delivery

simultaneously or subsequently. The same shall apply if payments are made against specified outstanding amounts. Should there be evidence indicating that a purchaser is unable to pay or that such inability is impending, we shall be entitled to terminate the contract without notice and to demand restitution of the goods.

8.2. Any adaptation or processing of retained-title goods is done on our behalf as the manufacturer in accordance with Section 950 of the BGB without creating any obligation on our part. All such processed goods are deemed to be retained-title goods as defined in clause 8.1. If retained-title goods are processed, combined or included by the purchaser with third party goods, we shall be entitled to co-ownership of the new goods to the ratio of the invoice value of the retained-title goods to the other goods used. Should our right of title become void as a result of such combination or inclusion, the purchaser agrees with immediate effect to assign to us his title or expectant rights in the new goods or object to the extent of the invoice value of the retained-title goods and to retain same on our behalf at no charge. The co-ownership rights at issue shall be deemed to be retained-title goods as defined in clause 8.1.

8.3. The purchaser may sell on, process or combine the retained-title goods with other items or otherwise install them (resale) only as part of his normal business activities and as long as he is not in default. He shall not be entitled to dispose of the retained-title goods in any other way. We must be informed immediately of any third party seizure of or other access to the retained-title goods.

8.4. The purchaser agrees with immediate effect to assign to us his receivables arising from the resale of the reserved-title goods. These shall serve as security to the same extent as the retained-title goods. The purchaser will only be entitled and authorised to resell goods on the assurance that all receivables becoming due to him as a result will be transferred to us.

8.5. If the retained-title goods are sold by the purchaser at an inclusive price together with third party goods, the receivables arising from such sale shall be assigned to us in the amount of the invoice value of the retained-title goods sold in each instance.

8.6. If the receivable amount assigned is included in a current account, the purchaser hereby assigns to us a part of the balance corresponding to the amount of the receivable sum inclusive of the final balance from the current account.

8.7. The purchaser will be entitled to collect such receivables on our behalf until such time as we revoke this right. We shall be entitled to revoke this right if the purchaser fails to meet his payment obligations arising from his business transactions with us or if we become aware of circumstances likely to lessen substantially the purchaser's creditworthiness. If the conditions are such that we wish to exercise our right of revocation, the purchaser must on request inform us forthwith of the receivable sums assigned and the debtors to which these apply, provide all information necessary to collect such debts, hand over to us all associated documents and notify the debtor of the assignment.

8.8. Our assertion of retention of title shall not constitute revocation of the contract unless we expressly state this in writing. The purchaser's right to own the retained-title goods shall lapse if he fails to perform his obligations under this or any other contract.

### 9. LIABILITY FOR FAULTY GOODS

9.1. We do not accept liability for unsuitable or improper use, particularly excessive stress, faulty assembly or faulty operation by the purchaser or third parties, natural wear and tear, faulty or negligent usage or handling, particularly by untrained staff.

9.2. The purchaser agrees to inspect all deliveries carefully for completeness and adequacy immediately upon receipt – even if samples or trial items were previously supplied. The delivery is deemed to have been accepted if a deficiency has not been reported by letter, telex or fax within 10 working days of the goods arriving at their destination, or, if the deficiency could not be found during due inspection, within 10 working days of discovering same. This also applies to multiple deliveries. A multiple delivery is deemed to have been accepted if no complaint is lodged within 10 days of the goods arriving at their destination. Our field staff are not authorised to acknowledge quantity or deficiency complaints.

9.3. A purchaser accepting faulty goods knowing them to be defective shall only be entitled to the claims and rights in respect of deficiencies if he reserves the right to these by reason of deficiency on acceptance.

9.4. We guarantee to meet the purchaser's claims in respect of defective goods for a period of two years, starting in each instance with the date of delivery. This shall not affect liability for defects of title as defined by statutory provision. Liability for losses arising from defects shall be governed by clause 10.

9.5. Where there are valid grounds for complaint, the purchaser shall initially only have a claim for defects to be made good, which we may effect as we see fit either by repair or by supplying a defect-free item. If such remedial action fails to work, is unacceptable to the purchaser (Section 440 of the BGB) or

superfluous to his requirements, the purchaser shall immediately have the right to reduce the purchase price or, if he so chooses, to revoke the contract or to demand damages in place of any work or reimbursement of wasted expenditure in accordance with clause 10, because:

a) we ultimately decline to make good,  
b) we do not effect the make-good work on a contractually agreed date or within a specific period and in the contract the purchaser has contractually tied his continued interest in the execution of the contract to the timely provision of services, or

c) there are special circumstances, which, when considering the interests of both parties, justify immediate cancellation (Section 323, para. 2 of the BGB).

9.6. Where we deem it necessary to effect repairs or replacement deliveries, the purchaser shall allow us sufficient time and opportunity for such repairs or replacement deliveries, failing which our liability for the deficiency shall be deemed to have been discharged. Only in urgent cases where operational safety is endangered or in order to avoid disproportionately large losses, in which case we must be informed immediately, or if we are late in rectifying the defect, shall the purchaser have the right to rectify the defect himself or to have it rectified by others and then to claim reimbursement of the necessary costs from us.

9.7. The warranty period for the goods replacing a faulty item will also be two years. It will run at least until the expiry date of the original warranty period for the goods supplied.

9.8. Any manufacturer guarantees given by us are regulated in the applicable guarantee conditions. These can be viewed at [www.alape.com](http://www.alape.com).

### 10. LIABILITY FOR DAMAGES

10.1. We accept liability for damages arising from injury to life, bodily harm or impaired health in accordance with statutory provisions.

10.2. Our liability for breach of duty and our non-contractual liability shall, moreover, be limited to wilful intent and gross negligence. Liability for gross negligence of our employees, staff and vicarious agents is hereby excluded.

10.3. Breaches of material contractual obligations (cardinal duties) are excluded from clause 10.2. In such instances, even in cases of only minor negligence, we shall be liable for own negligence and that of our employees, staff and vicarious agents.

10.4. Liability is restricted to the typical contractual losses which we could have expected at contract signature based on the circumstances known to us at that time.

10.5. Any further liability is excluded, irrespective of its legal basis. In particular, we will not accept liability for lack of commercial success, loss of profits, consequential loss, losses as a result of defects or losses arising from third party claims.

10.6. The aforementioned limitations on liability apply equally to claims for reimbursement of wasted expenditure (Section 284 of the BGB).

10.7. Claims against us for damages on any legal grounds whatsoever shall lapse within two years of statutory commencement of the period of limitations and in any case no later the date of delivery of the item.

10.8. There is no shift in the burden of proof to the disadvantage of the purchaser connected with the above provisions.

10.9. Claims for compensation under the Product Liability Act remain unaffected.

### 11. RETURNED GOODS

11.1. Goods may only be returned by prior arrangement and must be sent carriage paid.

11.2. We charge a handling fee for returns of 30% of the net value of the goods, plus any reprocessing costs.

### 12. PLACE OF EXECUTION, JURISDICTION, APPLICABLE LAW

12.1. The place of execution for all obligations of both parties to this contract shall be Goslar.

12.2. Any disputes involving registered trade operators shall exclusively be settled before a competent court of law having jurisdiction for our headquarters. We shall, however, also be entitled to bring actions against the purchaser in other jurisdictions.

12.3. The relationship between ourselves and the purchaser shall be governed by German law with the exception of the United Nations Convention on the International Sale of Goods (CISG) and the provisions of international private law.

12.4. Should subsequent circumstances cause individual provisions of these Terms and Conditions to be or become invalid, this shall not affect the validity of the remaining provisions.

# General Information

For Alape, comprehensive support in all planning phases is a matter of course. So if you need information on our product range or have any other questions, the representatives responsible for your region are happy to assist. Furthermore, you can reach our German office on +49(0)5321.558-111. Our service team provides partner-like and competent support. You can also find out more quickly and easily in the Internet.

Under [www.alape.com](http://www.alape.com) you have the following services at your fingertips:

- Cutout dimensions for built-in, semi-built-in, sit-on and dish basins
- 2D and 3D drawings of all the Basic Components in dxf file format
- Technical data sheets and installation instructions as pdf
- Tender specifications in pdf format

# Alape Representations abroad

## Australia

Reece Australia Ltd  
118 Burwood Highway  
3125 Burwood Victoria  
Australia  
Phone: +61 (0) 3.92740000  
Fax: +61 (0) 3.92740197  
E-Mail: marketing@reece.com.au

## Austria

Dornbracht Austria GmbH  
IZ NÖ Süd, Straße 7, Objekt 58D, Top 6  
2355 Wiener Neudorf  
Austria  
Phone: +43 1 417 06 90  
E-Mail: at@dornbracht.com

## Baltic States

Arunas Jazukevicius  
Sv. Gertrudos Street 68/5  
44269 Kaunas  
Lithuania  
Phone: +370 686 303 13  
E-Mail: arunas.jazukevicius@burgbad-baltics.com

## Belgium

Onderdeel van Dornbracht B.V.  
Rivium Boulevard 21  
2909 LK Capelle aan den IJssel  
Nederland  
Phone: +32 (053) 81 02 78 (NL)  
Phone: +32 (053) 81 02 79 (FR)  
E-Mail: bnl@dornbracht.com

## Bulgaria

Reallize Consult S.R.L.  
Strada Grivitei, 98  
105600 Campina, Prahova  
Romania  
Phone: +40 741 288 516  
Mobile: +40 722 654 654  
E-Mail: office@reallize.ro

## China

Dornbracht (Shanghai) Commercial Ltd.  
Unit 3-1, No. 2937 Longteng Avenue  
Xuhui District – Shanghai 200030  
China  
Phone: +86 (0) 21-6360 6930  
Fax: +86 (0) 21-6361 4155  
E-Mail: cn@dornbracht.com

## Czech Republic

Katja Kramárová  
Wiesenthalova 8  
155 00 Prague 5  
Czech Republic  
Mobile: +420 724 207 528  
E-Mail: kramarova@dornbrachtgroup.cz

## France

Dornbracht France SARL  
3 rue de Téhéran  
75008 Paris  
France  
Phone: +33 (0) 1 40 21 10 70  
E-Mail: fr@dornbracht.com (Général)  
E-Mail: service.fr@dornbracht.com  
(SAV / Technique)

## Greece

Klimatechniki S.A.  
Areopoleos 1  
14564 Kifissia - Athens  
Greece  
Phone: +30 (210) 81 60 061  
Fax: +30 (210) 81 61 255  
E-Mail: info@davoline.gr

## Germany

Alape GmbH  
Am Gräbicht 1-9  
38644 Goslar  
Germany  
Phone: +49 (0) 5321 558-0  
Fax: +49 (0) 5321 558-400  
E-Mail: info@alape.com

## Hong Kong

The B.S.C. Group of Companies  
19th Floor, Sino Favour Centre  
1 On Yip Street, Chai Wan  
Hong Kong  
Phone: +852-2510 2328  
Fax: +852-2807 1903  
E-Mail: bsc@bschk.com

## Hong Kong

**HK/MAC, JP, KR, TW, NZ:**  
Dornbracht Asia Pacific Ltd  
Room 1305 & 1307, Sino Favour Centre,  
1 On Yip Street, Chai Wan  
Hong Kong  
Phone: +852-2505 6254  
Fax: +852-2505 9722  
E-Mail: mail@dornbracht.com

## Hungary

Z-A Design Stúdió Kft.  
Kondor Béla utca 2.  
2000 Szentendre  
Hungary  
Phone: +36 26 381553  
Mobile: +36 70 775 0954  
Fax: +36 26 381553  
E-Mail: dornbracht@zadesign.hu

## India

Dornbracht India Pvt Ltd.  
1102, Wing-A, Cello Triumph, I.B. Patel Road  
Opp. Laghu Udyog, Goregaon (East)  
Mumbai-400063 / India  
Phone: +91 22 26853900  
+91 22 26853912  
Fax: +91 22 26853900  
E-Mail: in@dornbracht.com

## Indonesia

PT CJ Trading  
Jakarta Design Center 4th Floor No. SR 15  
Jl. Gatot Subroto 53, Slipi  
10260 Jakarta  
Indonesia  
Phone: +62-21 572 0519  
Fax: +62-21 572 0539  
E-Mail: cjsales@cbn.net.id

## Italy

Dornbracht Italia s.r.l.  
Via Morimondo 2/5  
20143 Milano  
Italy  
Phone: +39 02 818 343 1  
E-Mail: it@dornbracht.com

## Japan

Reliance Inc.  
Shinkoku Kokusai New Bldg 1F 6-3,  
Nishishinjuku6-chome Shinjuku-ku,  
Tokyo 160-0023 / JAPAN  
Mari Kaneko  
Phone: +81 3 5909 0535  
Fax: +81 3 5909 0537  
E-Mail: kaneko@reliance.co.jp

## Lebanon

Naji Kanafani & Fils  
Corniche Mazraa, Habib Building  
Beirut 1105-2040  
Lebanon  
Phone: +961 1 307 400  
Fax: +961 1 307 403  
E-Mail: info@kanafani.com.lb

# Alape Representations abroad

## Malaysia

GC Building Technologies (M) Sdn Bhd  
No. 7 Jalan Perintis U1/52  
Temasya Industrial Park, Section U1  
Glenmarie  
40150 Shah Alam, Selangor / Malaysia  
Phone: +603 5569-9689  
Fax: +603 5569-8689  
E-Mail: gcmal@gcbuildtech.com.my

## Marocco

Medisol. c/o Najib Laghmar  
138, Angle Bd Omar El Khayam et Rue  
Banafsaj 20200 - Beauséjour - Casablanca  
Marocco  
Phone: +212 522.9451-32/35  
Fax: +212 522.9451-39  
E-Mail: nlaghmar@medisol.ma

## Moldova

Reallize Consult S.R.L.  
Strada Grivitei, 98  
105600 Campina, Prahova  
Romania  
Phone: +40741 288 516  
Mobile: +40722 654 654  
E-Mail: office@reallize.ro

## Netherlands

Onderdeel van Dornbracht B.V.  
Rivium Boulevard 21  
2909 LK Capelle aan den IJssel  
Netherlands  
Phone: +31 (0) 10 52 43 400  
E-Mail: bnl@dornbracht.com

## New Zealand

Metrix Import Ltd.  
Parnell, Auckland 1010,  
PO BOX 100-840  
NSMC 0745  
New Zealand  
Phone: +64-9 444 5656  
Fax: +64-9 444 5151  
E-Mail: info@metrix.co.nz

## Nordic Countries DK, IS, FI, NO, SE

Dornbracht Nordic A/S  
Masteskurene, skur 7  
Galionsvej 33  
1437 Copenhagen K  
Denmark  
Phone: +45 8987 7150  
E-Mail: nordic@dornbracht.com

## Philippine

Focus Global Inc.  
Pioneer Corner Reliance Streets,  
Mandaluyong Manila  
Philippine  
Phone: +63 2 634 8587  
Fax: +63 2 634 8738  
E-Mail: customerservice@focusglobalinc.com

## Poland

Honorata Broniowska  
Ul. Janockiego 41  
66-400 Gorzow WLKP.  
Poland  
Phone: +48 (0) 95-728 261 7  
Mobil: +48 (0) 602471319  
E-Mail: biuro@dornbrachgroup.pl

## Portugal

Gama Uno  
Rua da Cruz, 86  
2565-031 Campelos  
Portugal  
Phone: +351 261 430 070  
Mobile: +351 261 430 079  
E-Mail: gamauno@gamauno.pt

## Romania

Reallize Consult S.R.L.  
Strada Grivitei, 98  
105600 Campina, Prahova  
Romania  
Phone: +40741 288 516  
Mobile: +40722 654 654  
E-Mail: office@reallize.ro

## Russia

OSA GmbH & Co. KG  
Panfilovskiy pereulok 5  
121099 Moscow  
Russia  
Phone: +7 (499) 241 8259  
E-Mail: osa@o-s-a.de

## Serbia

**SRB, BiH, MNE, MK, HR**  
DOZEN Stars d.o.o.  
Nenad Djukic  
Omladinskih Brigada 90A  
Airport City Belgrade / 11070 Belgrade (Serbia)  
Phone: +381 (11) 6555120  
E-Mail: nenadkop@yahoo.com  
E-Mail: zoja@dozenstars.com

## Singapore

**SG, MY, ID, PH, TH, VN, KH, MM, MV**  
Dornbracht South East Asia Pte. Ltd.  
Level 18, Republic Plaza II 9 Raffles Place  
048619 Singapore  
Phone: +65 9118 8658  
E-Mail: sea@dornbracht.com

## Slovakia

Katja Kramárová  
Wiesenthalova 8  
155 00 Prague 5  
Czech Republic  
Mobile: +420 724 207 528  
E-Mail: kramarova@dornbrachgroup.cz

## Slovenia

Leon Ladic s.p.  
Nikova ulica 10  
2000 Maribor  
Slovenia  
Phone: +386 51 387 458  
E-Mail: leon.ladic@gmail.com

## South Africa

Flush Bathrooms Interiors  
Siebhan Thomas  
PO Box 148 / Paarden Eiland  
Cape Town 7420  
South Africa  
Phone: +27 825 742 432  
E-Mail: siobhan@flushbathrooms.co.za

## South Korea

E.L. Systems  
4th Fl., Jaemyeong Bldg., 893-12  
Bangbae 1-dong, Seocho-gu, Seoul  
South Korea  
Phone: +82 (0) 2.3445-3781  
Fax: +82 (0) 2.3445-3784  
E-Mail: importing@chol.com

## Spain

Dornbracht España S.L.  
Joaquim Molins 5-7, 1º 4ª  
08028 Barcelona  
Spain  
Phone: + 34 932 723 910  
Fax: + 34 932 723 913  
E-Mail: iberia@dornbracht.com

# Alape Representations abroad

## Switzerland

Dornbracht Schweiz AG  
Letziweg 9 (Showroom)  
CH-4663 Aarburg  
Switzerland  
Phone: +41 (0) 62 787 20 30  
Fax: +41 (0) 62 787 20 40  
E-Mail: [ch@dornbracht.com](mailto:ch@dornbracht.com)

## Taiwan R. O. C.

Lafon Trading Co. Ltd.  
11F-3, No.12, FU-Hsing 4th Rd.  
Chien-Chen Dist.  
80661 Kaohsiung  
Taiwan  
Phone: +886-7 338 2000  
Fax: +886-7 331 8000  
E-Mail: [info@lafon.com.tw](mailto:info@lafon.com.tw)

## Thailand

Arkitektura  
125/1 Thonglor Soi 10  
Sukhumvit 55 Rd., Bangkok 10110  
Thailand  
Phone: +662 392 5460-4  
E-Mail: [info@arkitektura.co.th](mailto:info@arkitektura.co.th)

## Tunisia

SOTEM Distribution  
Siège: 5 Avenue Med V  
2015 Le Kram  
Tunisia  
Phone: +216 719 74-774/775  
Fax: +216 719 76-421  
E-Mail: [showroomtunis@sotemtn.com](mailto:showroomtunis@sotemtn.com)  
[www.sotemtn.com](http://www.sotemtn.com)

## Turkey/Central Asia

Dornbracht  
Regus Maslak Orjin  
Orjin Maslak İş Merkezi  
Eski Büyükdere Cad. No: 27  
Zemin Kat Maslak Sarıyer  
34485 İstanbul / Turkey  
Phone: +90 (0) 212 284 9495  
E-Mail: [tr@dornbracht.com](mailto:tr@dornbracht.com)

## Ukraine

Olena Khelemendik  
24/1 Levka Matsievich str., ap.1  
UA-03151 Kyiv  
Ukraine  
Phone: +38 (0) 44-244 7682  
Fax: +38 (0) 44-244 7682  
E-Mail: [office@helena.com.ua](mailto:office@helena.com.ua)

## United Arab Emirates / Middle East

**AE, BH, EG, IQ, JO, KW, LB, OM, PL, QA, SA, SY, YE**

Dornbracht Group International GmbH  
Rep Office  
PO Box 114268 / Dubai (UAE)  
Phone: +971 4 380 6611  
Fax: +971 4 380 6606  
E-Mail: [middleeast@dornbracht.com](mailto:middleeast@dornbracht.com)

## United Kingdom

Dornbracht UK Ltd.  
Unit 8 & 9 Bow Court  
Fletchworth Gate  
Coventry  
CV5 6SP / UK  
Phone: +44 (0) 2476 717 129  
Fax: +44 (0) 2476 718 907  
E-Mail: [gb@dornbracht.com](mailto:gb@dornbracht.com)

## USA

North American Headquarters  
Dornbracht/Alape  
1700 Executive Drive South  
Suite 600 / Duluth, GA 30096  
USA  
Phone: +1 (800) 774 1181  
Fax: +1 (800) 899 8527  
E-Mail: [americas@dornbracht.com](mailto:americas@dornbracht.com)





Imprint

**Publisher** Alape GmbH Goslar/Germany

**Graphics** Heine/Lenz/Zizka Projekte GmbH, Frankfurt/Berlin

**Printing** Meinders & Elstermann, Belm/Germany

**Design** Partner busalt design, Holzminden/Germany - Wolfgang Hartauer, London/Great Britain - sieger design, Sassenberg/Germany

Reprinting or reproduction of this manual or extracts thereof, irrespective of the method used, is only permitted with the consent of the manufacturer. If you require a components manual, we would be pleased to provide you with one.

Subject to model, programme and technical changes, as well as errors.

The General Terms and Conditions of Alape GmbH apply (see [www.alape.com](http://www.alape.com)).

All previous Product Lists become invalid with the publication of this Product List.

The Product List is valid from the 1st of April 2022.

Art.No. 0164 000 022



## Colour matrix – Glossy and matt colours

### Standard colour



000 Alpin-white

### Glossy colours

Surcharge 30% of the gross list price of the model.



156 Grey



201 Black

### Matt colours

Surcharge 30% of the gross list price of the model.

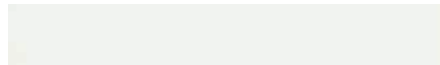

004 Matt white



154 Matt grey



240 Matt black

UB Undermount basins / EB Built-in basins / HB Semi-recessed basins															
Mould	S, K, O, R			Sondo		Q		RE		Stream		ME (3mm)		KE (3mm)	
Basin type	UB	EB	HB	UB	EB	UB	EB	UB	EB	UB	EB	UB	EB	UB	EB
Grey 156	X	X	X	X	X	X	X	X	X	X	X	-	-	X	X
Black 201	X	X	X	X	X	X	X	X	X	X	X	X	X	X	X
Matt white 004	X	X	X	X	X	X	X	X	X	X	X	X	X	X	X
Matt grey 154	X	X	X	X	X	X	X	X	X	X	X	-	-	X	X
Matt black 240	X	X	X	X	X	X	X	X	X	X	X	-	-	X	X

AB Sit-on basins / SB Dish basins													
Mould	K	R	K	O	CO	Sondo	Q	RE	Stream		ME (3mm)	KE (3mm)	
Basin type	AB	AB	SB	SB	SB	AB	AB	AB	AB	SB	AB	AB	
Grey 156	X	-	X	X	X	X	-	-	-	X	X	X	
Black 201	X	X	X	X	X	X	-	-	X	X	X	X	
Matt white 004	X	X	X	X	X	X	-	-	X	X	X	X	
Matt grey 154	X	-	X	X	X	X	-	-	-	X	-	X	
Matt black 240	X	-	X/SP*	X	X	SP*	-	-	-	SP*	-	X/SP*	

WT Washstands															
Mould	IC, MC	K	CO	CO	RS	QS		RE	PR	GR	Stream	XS	XXS	WT.RX...KE	
Basin type	WT	WT.RX	WT	WT.RX	WT	WT	WT.RX	WT	WT	WT	WT	WT	WT	Basin	Pillar
Grey 156	-	o.r.	X	X	X	o.r.	o.r.	-	-	-	-	-	-	X	X
Black 201	X	X	X	X	X	o.r.	o.r.	-	X	X	X	X	X	X	X
Matt white 004	X	X	X	X	X	o.r.	o.r.	-	X	X	X	-	X	X	X
Matt grey 154	-	X	X	X	X	o.r.	o.r.	-	-	-	-	-	-	X	X
Matt black 240	-	X	X	X	X	o.r.	o.r.	-	-	-	-	-	-	X	X

**UB** – Undermount basin **EB** – Built-in basin **HB** – Semi-recessed basin **AB** – Sit-on basin **SB** – Dish basin **WT** – Washstand

SP: Serial product X: available in this colour - : not available in this colour o. r. : on request

### Pillar washstand

If a matt colour is chosen, the wall bracket of the pillar washstands is either matt white or matt black, thus varying from the colour of the pillar.

- matt white wall bracket if the colour is: matt white.
- matt black wall bracket if the colour is: black/grey/matt black/matt grey

### Please note:

- Special colours on request
- \* In the chapter Special glazes you will find series products in matt black as well as other products in different colors and surfaces

Alape GmbH  
Am Gräbicht 1–9  
38644 Goslar

Postfach 2812  
38628 Goslar  
Germany

Tel +49 (0)5321 558 0  
Fax +49 (0)5321 558 400  
export@alape.com

Service Hotline  
Tel +49 (0)5321 558 111

**[www.alape.com](http://www.alape.com)**

**Alape**<sup>™</sup>